

人工智能在猎豹内容产品的应用



闵可锐

News Republic介绍

面向海外的个性化内容推荐系统

- 数千正版媒体源 (BBC, CNN, AP...)
- 数千万的下载安装量
- Google Play新闻杂志类Top 10



News Republic介绍

每日新增超过10万篇内容

- 分词
- 词性分析
- 命名实体分析
- 提取关键词
- 情感分析
- . . .

为何需要语义分析

通过对符号字符串的解析，回答一篇文章在讲什么（Meaning），寻找与之相关的文章和潜在感兴趣的用户

理解文章 \Rightarrow 理解用户

为何需要语义分析

传统基于关键词理解：TF*IDF，Okapi BM25

二义性：从词语到句子，从语法到语义

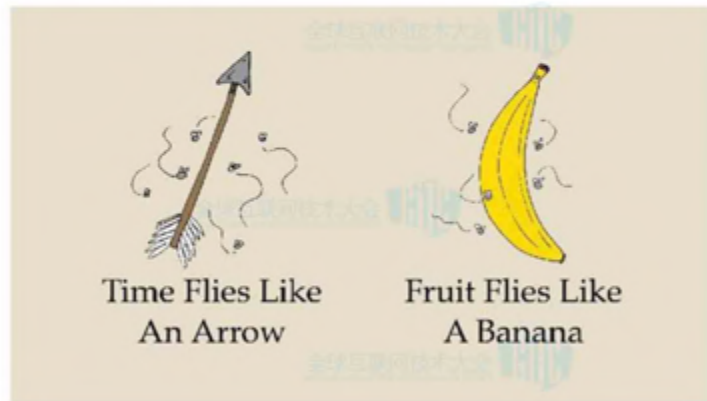

为何需要语义分析

传统基于关键词理解：TF*IDF, Okapi BM25

二义性：从词语到句子，从语法到语义

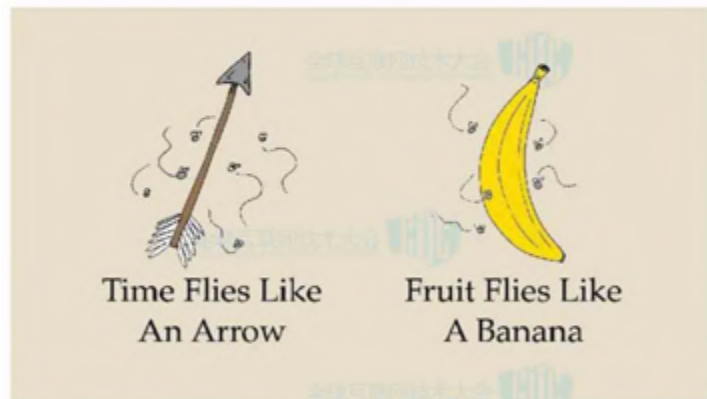

Time: 时间/计时/时代周刊? Flies: 飞行/苍蝇? Like: 像/喜欢?

向量表示

从词向量到文章向量

- 词向量: $w \in \mathbb{R}^d, w \in V$
- 文章向量: $c \in \mathbb{R}^D, c \in \mathcal{D}$

BOW表达

- $c = \sum_i w_i$, 丢失词序信息

简单拼接

- $c = \text{concat}(w_1 w_2 \cdots w_n), D = dn$
- 保留词序, 向量空间大小不定

向量表示目标

映射为固定空间大小，方便使用

对词序敏感

能够 无标注 数据进行训练



向量表示目标

映射为固定空间大小，方便使用
对词序敏感

⇒ **Recurrent Neural Network**

$$h_t = f(h_{t-1}, x_t).$$

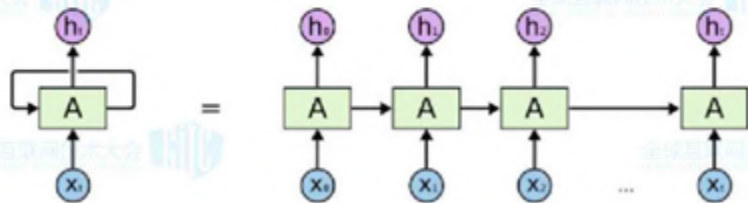

GRU

实际我们采用 Gated Recurrent Unit 进行实现

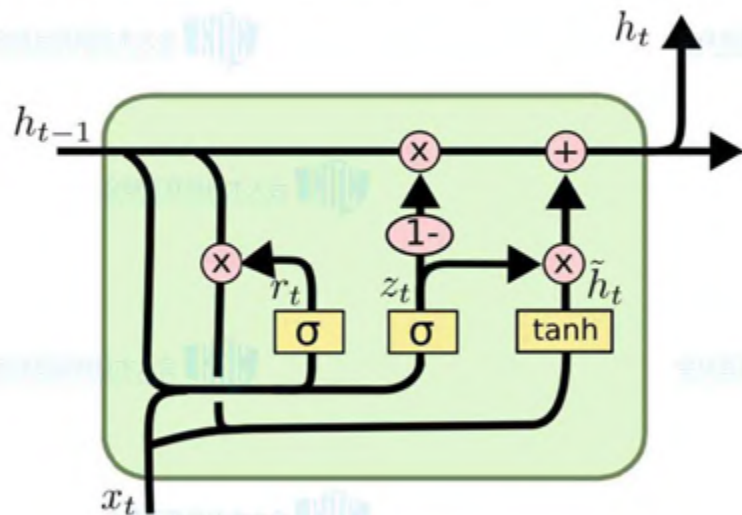

$$z_t = \sigma(W_z \cdot [h_{t-1}, x_t])$$

$$r_t = \sigma(W_r \cdot [h_{t-1}, x_t])$$

$$\tilde{h}_t = \tanh(W \cdot [r_t * h_{t-1}, x_t])$$

$$h_t = (1 - z_t) * h_{t-1} + z_t * \tilde{h}_t$$

Chung, Junyoung, etc. "Empirical Evaluation of Gated Recurrent Neural Networks on Sequence Modeling", 2014.

无标注训练

映射为固定空间大小，方便使用

对词序敏感

能够 无标注 数据进行训练

Title: Microsoft released two brand-new laptops this week, both killer Apple rivals

Date: 2017-06-17

Publisher: Business Insider

Content: This week, Microsoft released not one, but two new laptops.

First, you've got the Surface Laptop, an all-new device that's aimed at students. It also serves as the showcase device for Windows 10 S...

无标注训练

采用 Gated Recurrent Unit 实现 Encoder-Decoder 模型

输入：新闻内容 $(x_1 \cdots x_n)$

输出：新闻标题 $(t_1 \cdots t_l)$

$$\begin{aligned} \text{Encoder}(x_1 \cdots x_n) &\rightarrow h_n \in \mathbb{R}^D, \\ \text{Decoder}(h_n) &\rightarrow t_1 \cdots t_l. \end{aligned}$$

h_n 作为我们的语义向量 (Why?)

经过实验，我们采用512维向量 ($D = 512$) 训练结果

一些例子

Verizon Among Leading Bidders for Yahoo's Core Business: Bloomberg

1. Verizon Is Said to Be Near a Deal to Acquire Yahoo
2. UPDATE 1-Yahoo to be named Altaba, Mayer to leave board after Verizon deal
3. Verizon Communications : Yahoo's Marissa Mayer to resign from board after Verizon deal closes

SWAT team called to standoff incident in College Park

1. Woman shot in car near East Nashville apartments
2. Uber Driver Strikes Man 'Clearly Outside of Crosswalk:' San Jose Police Related
3. Man shot after confronting another driver over tailgating

效率优化

对于任意两个语义向量距离度量

$$\|h_i - h_j\|_2^2 = \sum_{k=1}^D (h_{ik} - h_{jk})^2$$

上千次浮点运算。

关注近邻查找而不是向量本身。

$$h^* = \mathcal{Q}(h_q) = \min_{h \in \mathcal{H}} \|h - h_q\|_2$$

近似解方案

KD-Tree

- 划分空间索引，搜索剪枝
- 精确查找时间复杂度： $O(\log n) \rightarrow O(n)$
- 近似查找时间复杂度： $O\left(\frac{1}{\epsilon^D} \log n\right)$
- 维数灾难



近似解方案

Locality-sensitive Hashing

对任意 $p, q \in \mathcal{M}$, 均匀采样 $h \in \mathcal{F}$ 满足

- 如 $d(p, q) \leq R$, $\mathbb{P}(h(p) = h(q)) \geq P$;
- 如 $d(p, q) > cR$, $\mathbb{P}(h(p) = h(q)) \leq P - \epsilon$.

存在 \mathcal{F} , $\rho < 1/c$, 使得

- 近似查找时间复杂度: $O(Dn^\rho)$
- 索引时间复杂度: $O(Dn^{1+\rho})$

Learning to Hash

LSH所采用的数据划分方式与具体数据无关 (data-independent)
对于具体数据集, 可以根据其分布得到更好的划分

目标:

学习映射 f , 对于 $h_i \in \mathcal{H}$, 对应的语义指纹 $b_i = f(h_i)$ 满足:

- 二值化: $b_i \in \{-1, 1\}^d$,
- 近似保距: $\forall i, j \text{ Hamming}(b_i, b_j) \approx c \cdot \|h_i - h_j\|_2$

Learning to Hash

$$f : \mathbb{R}^D \mapsto \mathbb{R}^d.$$

e.g. $[3.16, 1.05, \dots, -1.37] \mapsto 101101$.

优势:

- 时间：相似度比较由浮点运算变为整数XOR运算
- 空间：由 D 个实数变为了 $\lceil d/32 \rceil$ 个int32整数

DeepBit

DeepBit采用深度学习建模 $f(\cdot, W)$, W 为网络参数:

$$y_i = f(h_i, W), b_i = \text{sign}(y_i).$$

对于一个Mini-batch, 采用如下的损失函数:

$$\text{Loss} = L_{\text{quant}} + \alpha L_{\text{even}}$$

- $L_{\text{quant}} = \|y_i - b_i\|_2$
- $L_{\text{even}} = \sum_k \left(\sum_{i \in \mathcal{B}} b_{ik} \right)^2$

Kevin Lin, et al. Learning Compact Binary Descriptors with Unsupervised Deep Neural Networks, CVPR 2016.

DeepBit

DeepBit采用深度学习建模 $f(\cdot, W)$, W 为网络参数:

$$y_i = f(h_i, W), b_i = \text{sign}(y_i).$$

Algorithm 1: DeepBit

Input: Training set $X = [x_1, x_2, \dots, x_n]$

Output: A set of non-linear projection parameters \mathcal{W}

Step 1 (Initialization):

Initialize \mathcal{W} with pre-trained weights from ImageNet;

Step 2 (Optimization):

while $iter < max_iter$ **do**

 Fix \mathcal{W} update b_n using (1);

while $iter1 < max_iter1$ **do**

 Fix b_n update \mathcal{W} by minimizing the sum of (5)
 and (6);

 Fix \mathcal{W} update b_n using (1);

while $iter2 < max_iter2$ **do**

 Fix b_n update \mathcal{W} using (8);

return \mathcal{W} ;

DeepBit

上述算法采用的是 Alternating Minimization 的方式，交互更新 W 与 b_i ：

- 收敛速度较慢
- 更容易陷入次优（sub-optimal）的局部最优解

为什么不采用 端到端 的方式进行优化？

端到端优化

```
def train(h, w, alpha):  
    # forward step  
    y = f(h, w)  
    b = sign(y)  
  
    L = L_quant(y, b) + alpha*L_even(b)  
    dw = backprop(L)  
  
    w = w - lr*dw # SGD step
```

是否可行?

No!

```
def train(h, w, alpha):  
    # forward step  
    y = f(h, w)  
    b = sign(y) # <===== (*)  
  
    L = L_quant(y, b) + alpha*L_even(b)  
    dw = backprop(L)  
  
    w = w - lr*dw # SGD step
```

Sign函数

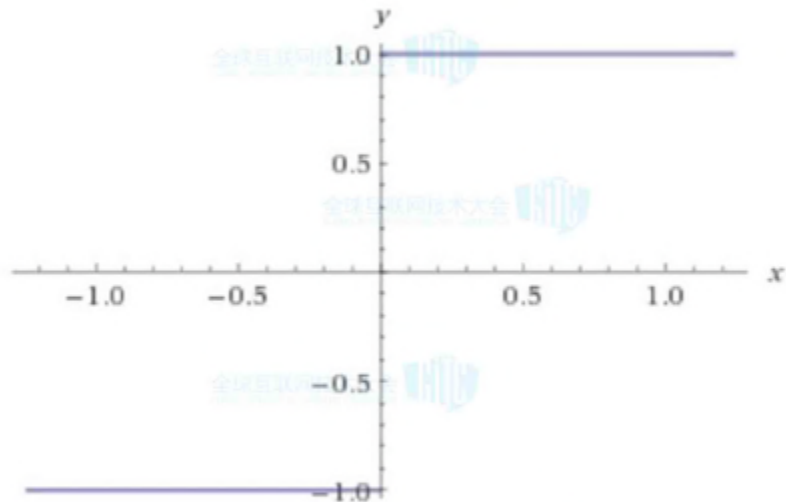

导数几乎处处为零!

在端到端更新中，没有可被反向传播的梯度

近似Sign函数

可以采用soft-sign函数对sign函数进行近似

$$\text{soft-sign}(x, \epsilon) = \frac{x}{\epsilon + |x|},$$

$$\text{sign}(x) = \lim_{\epsilon \rightarrow 0} \text{soft-sign}(x, \epsilon).$$

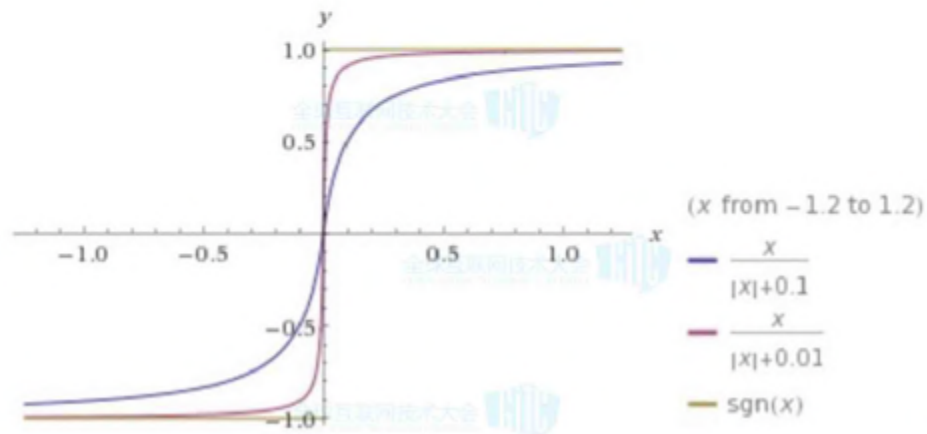

近似准确率

$$\text{sign}(x) = \lim_{\epsilon \rightarrow 0} \text{soft-sign}(x, \epsilon).$$

对于 x ，近似程度取决于 $\epsilon/|x|$ 的值。

为避免由于 $y = f(x, W)$ 过小带来的，引入 倒数正则项：

$$L_{\text{inverse}}^2 = \left\| \frac{1}{y} \right\|_2^2 = \sum_{i=1}^d \frac{1}{y_i^2}.$$

非均匀采样

近似保距： $\forall i, j$ Hamming(b_i, b_j) $\approx c \cdot \|h_i - h_j\|_2$

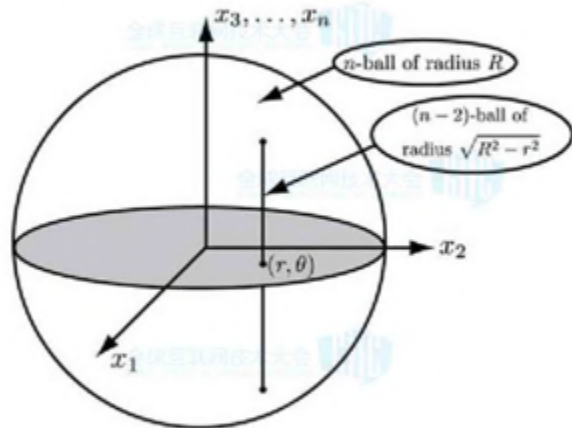

$$L_{\text{dist}} = L_{\text{KNN}} + L_{\text{rand}}.$$

L_{KNN} ： K 近邻近似误差， L_{rand} 随机点近似误差。

Put together

```
def train(h, w, alpha):  
    # forward step  
    y = f(h, w)  
    b = soft-sign(y) # approximate sign function  
  
    L = L_dist(b, h) + alpha*L_inverse(y)  
    dw = backprop(L)  
  
    W = W - lr*dw # SGD step
```

定义 f 网络

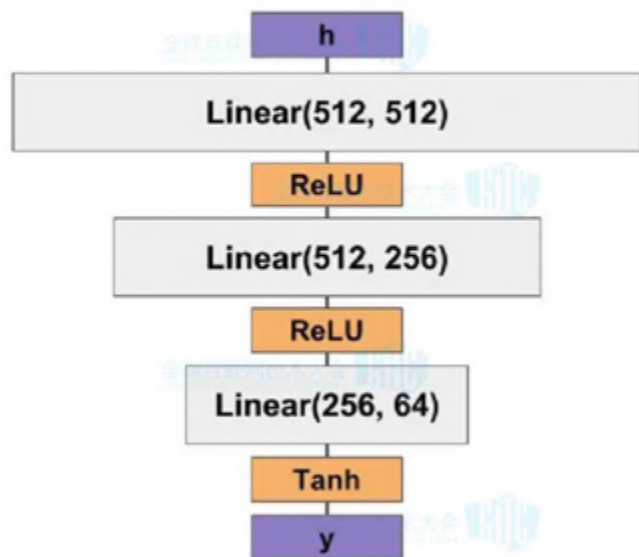

简单三层网络，总参数~1.6MB

实验结果

Batch-size=32完成50k次SGD迭代

固定 $\epsilon = 0.01$, 99%的 $b_{ij} \in [-1, -0.99] \cup [0.99, 1.0]$.

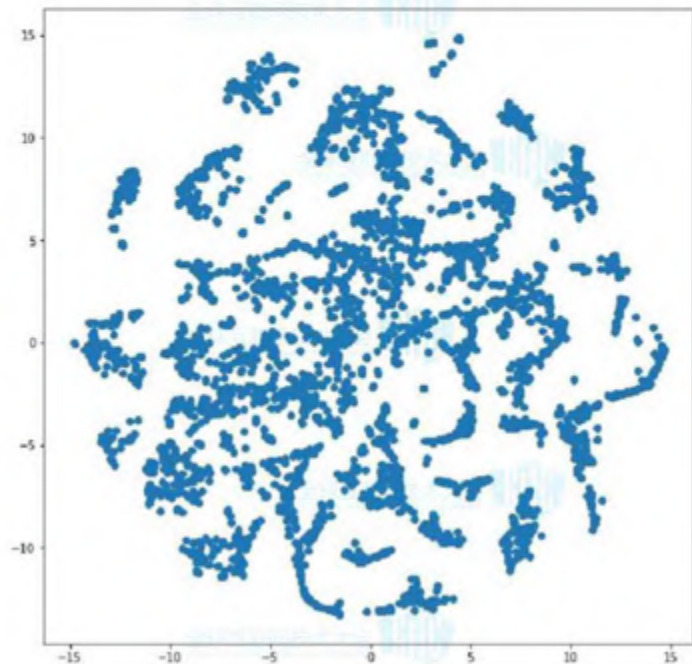

语义指纹碰撞

枪击/谋杀，被判处死刑

1. DA's office to seek death penalty in case against man accused of killing Kayla Gomez-Orozco
2. Whitehall shooting victim shot himself, lied to police about drive-by
3. Jury continues to mull attempted-murder charge in Clinton Township shooting
4. Inmate bites caseworker, punches guards at Nebraska prison

语义指纹碰撞

朝鲜导弹试验

1. US see increased activity by Chinese bomber aircraft
2. N. Korea Warns of 'Super-Mighty Preemptive Strike' as U.S. Plans Next Move
3. Donald Trump: If China wanted to end North Korean aggression, it could
4. U.S. sets up missile defence system in South Korea as North flexes muscles

深度学习图像理解应用

- 性感/色情图片识别
- LOGO/文本识别
- 不适图片识别
- 马赛克图片识别
-

生成马赛克图片

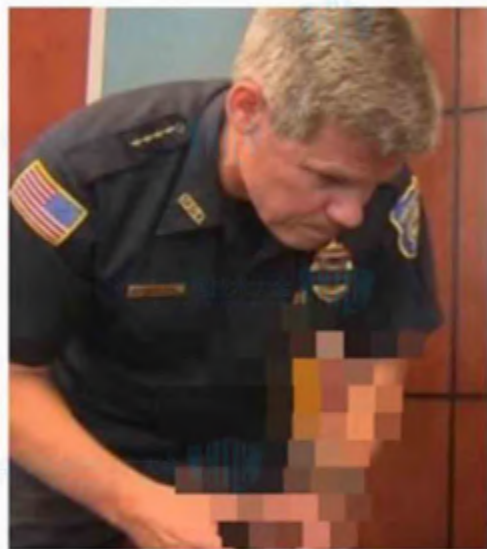

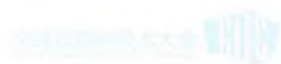

识别出的文字图片

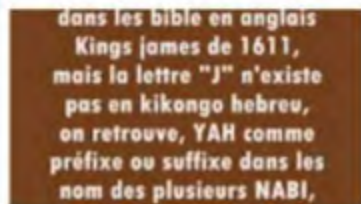
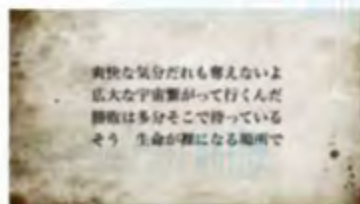
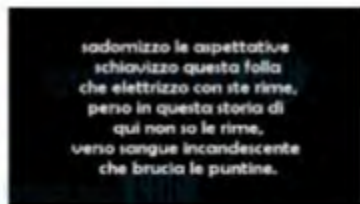
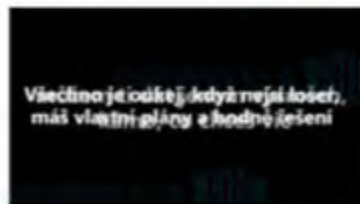



Thank you! 🙌



minkerui@cmcm.com

