

ORACLE®

甲骨文

免责声明

以下内容旨在概述产品的总体发展方向。该内容仅供参考，不可纳入任何合同。本演示不承诺提供任何材料、代码或功能，也不应将其作为购买决策的依据。此处所述有关 Oracle 产品的任何特性或功能的开发、发布和时间安排均由 Oracle 自行决定。

程序猿如何进化 —云上的开发运维一体化

胡平

甲骨文中国区资深架构师

甲骨文中国区云架构部

2017.4.16

不同类型的软件需要不同的实践

核心系统 - 运行后台系统

差异化软件 - 运行现有业务

创新业务 - 找到下一个业务商机



业务为中心	↔	IT为中心
顶线增长	↔	底线节省
小时为单元的发布	↔	季度为单元的发布
失败的更早	↔	失败的更晚
定制软件	↔	套装软件
敏捷	↔	瀑布式
基于产品	↔	基于项目

开发运维完整生命周期

持续集成, 持续交付和DevOps

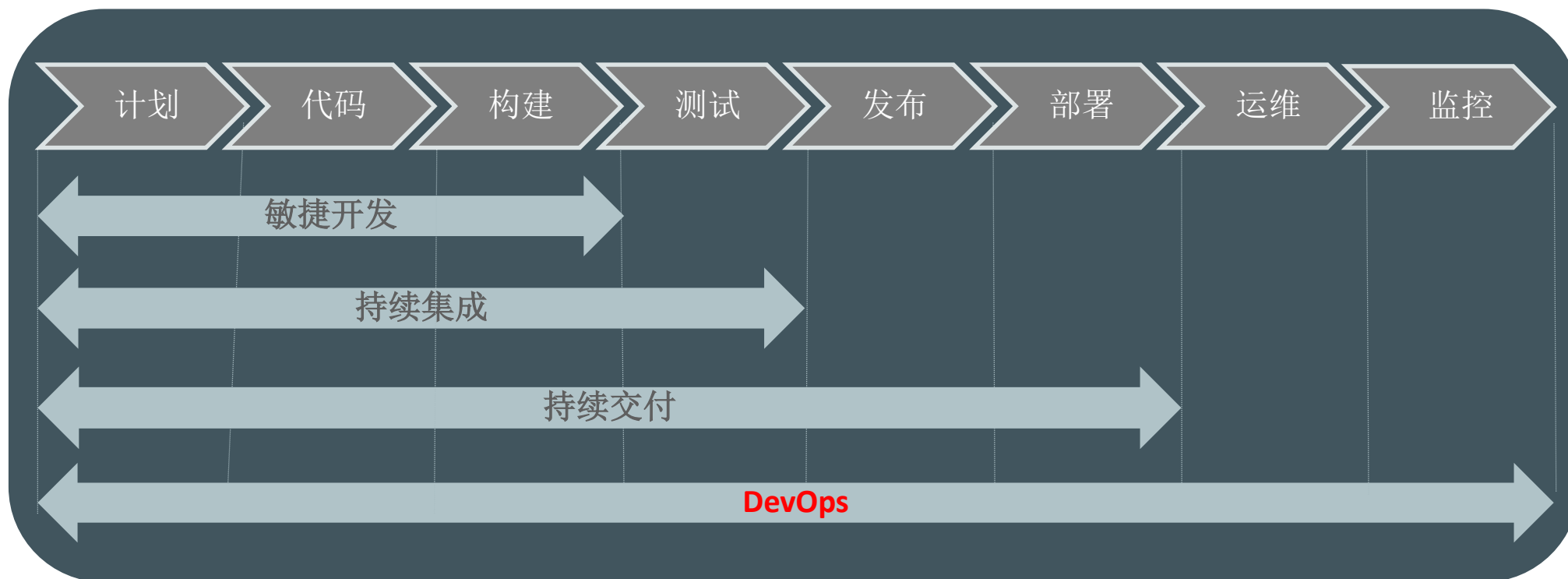

实现CI / CD 市面的工具集

开发的基础设施工具



团队基础设施工具

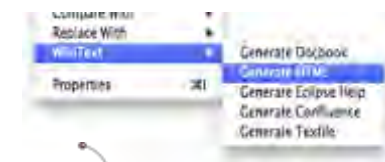

理想的解决方案

- 集成式运维解决方案
- 启动时间短、易于供应
- 维护成本很低
- 跟踪开发活动，并提供跟踪信息
- 无缝部署
- 灵活，可选择云或内部部署方案



DIY 或者PaaS方式?

第一步
选择合适工具



第二步
编写自动化脚本

```
# install jdk8
java_ark "jdk" do
  url "http://download.oracle.com/otn-pub/java/jdk/8-b132/jdk-8-linux-x64-bin"
  checksum "a8603fa62045ce2164b26f7c04859cd548ffe0e33bfc979d9fa73df42e3b3365"
  app_home '/usr/local/java/default'
  bin_cmds ["java", "javac"]
  action :install
end
```

第三步
执行脚本

```
[root@examplehost manifests]# puppet module install puppetlabs-java
```



DevOpS -> DIY

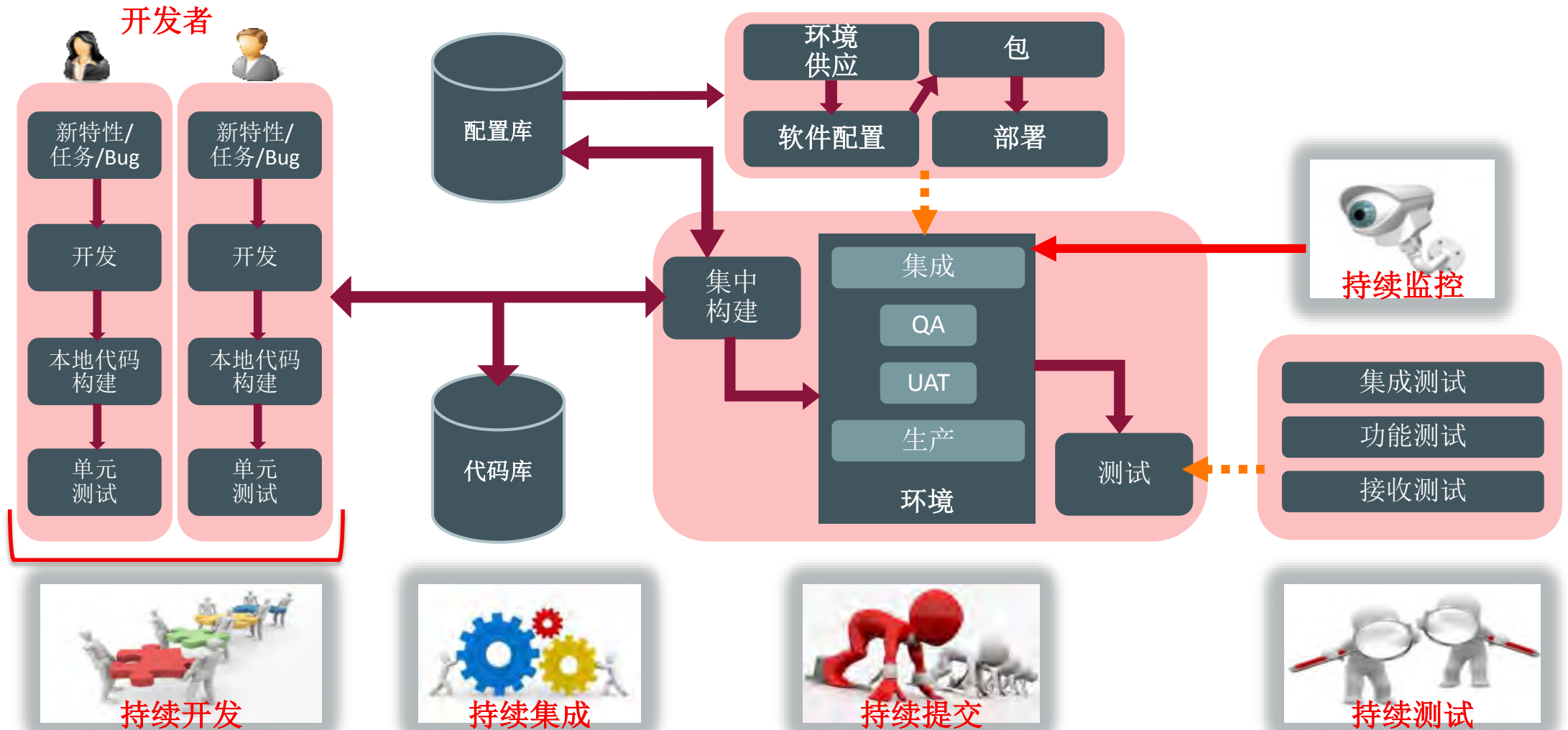

开始本地DIY的方式

初始化工作是极其耗时和昂贵的

- 购买硬件和软件
- 设置和安装组件
- 连接组件
- 配置IDE工具
- 维护和升级版本
- 安全接入到部署平台
- 构建你自己的DevOps环境



DevOpS -> 使用PaaS

ORACLE
DEVELOPER
CLOUD SERVICE

+ Other PaaS
Services

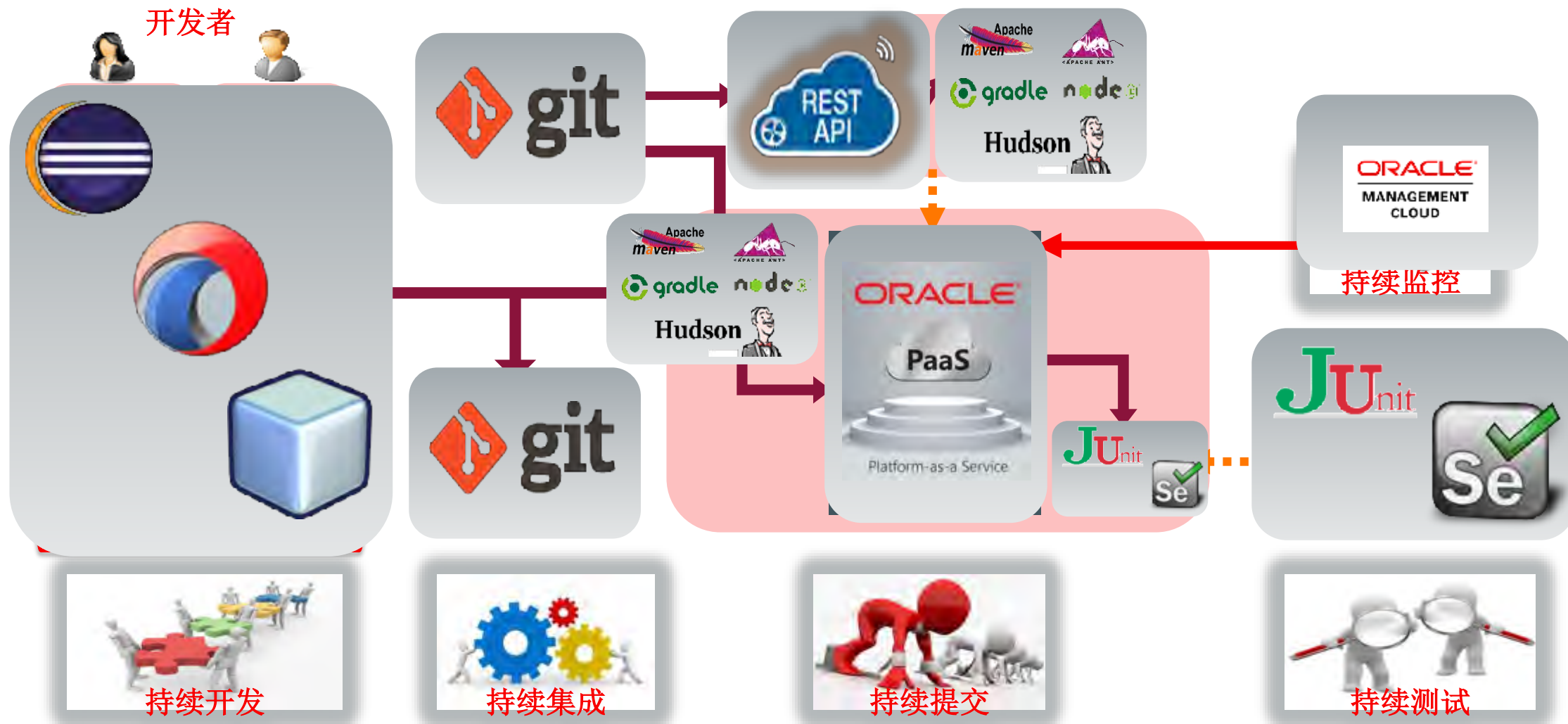

开始PaaS的方式

马上可用并经济高效

- 购买硬件和软件
- 设置和安装组件
- 连接组件
- 配置IDE工具
- 维护和升级版本
- 安全接入到部署平台
- 构建你自己的DevOps环境
- 使用你自己的DevOps环境

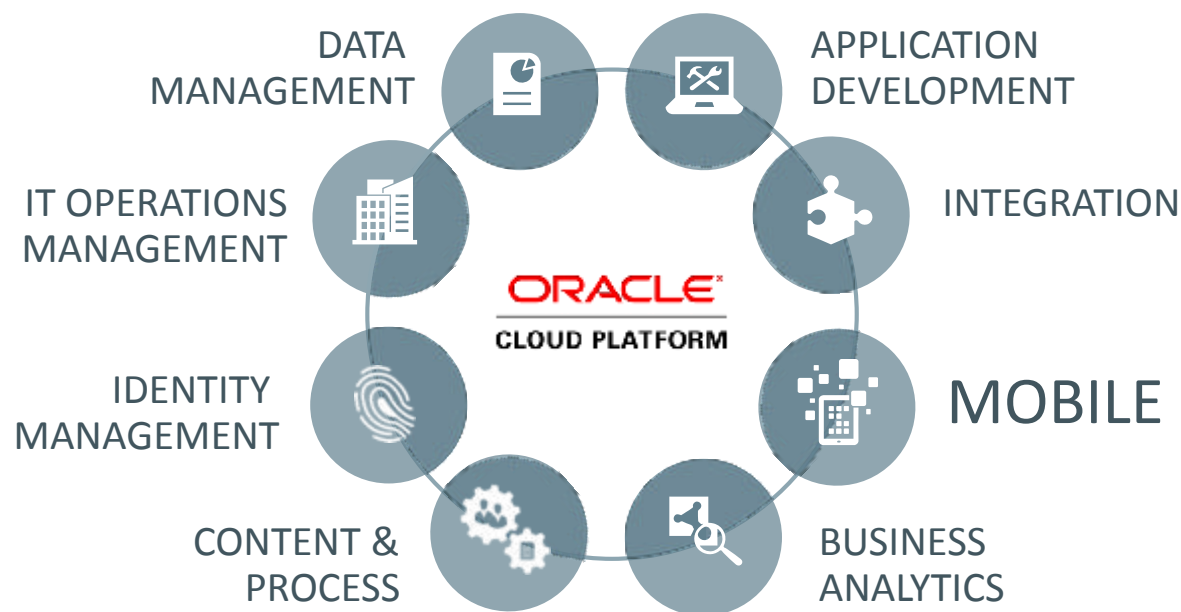

Oracle 自动化和集成的DevOps PaaS解决方案

管理云服务
应用性能监控
日志分析
容量规划

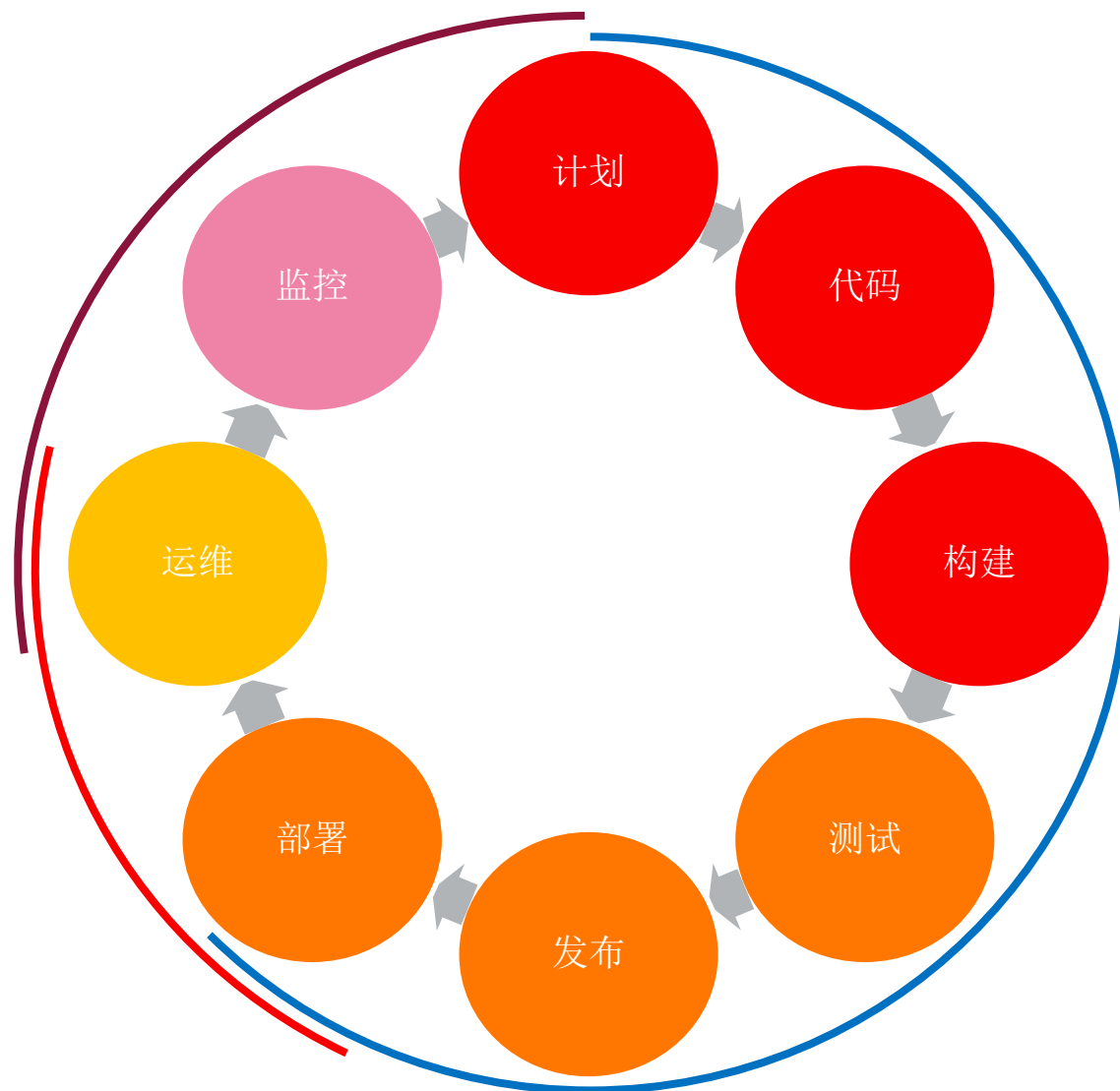

开发者云服务
敏捷开发
CI/CD - Java, 多语言
(微服务)

运行和部署云服务

OPC - JCS, ACCS

开发人员云服务：整合所有要素

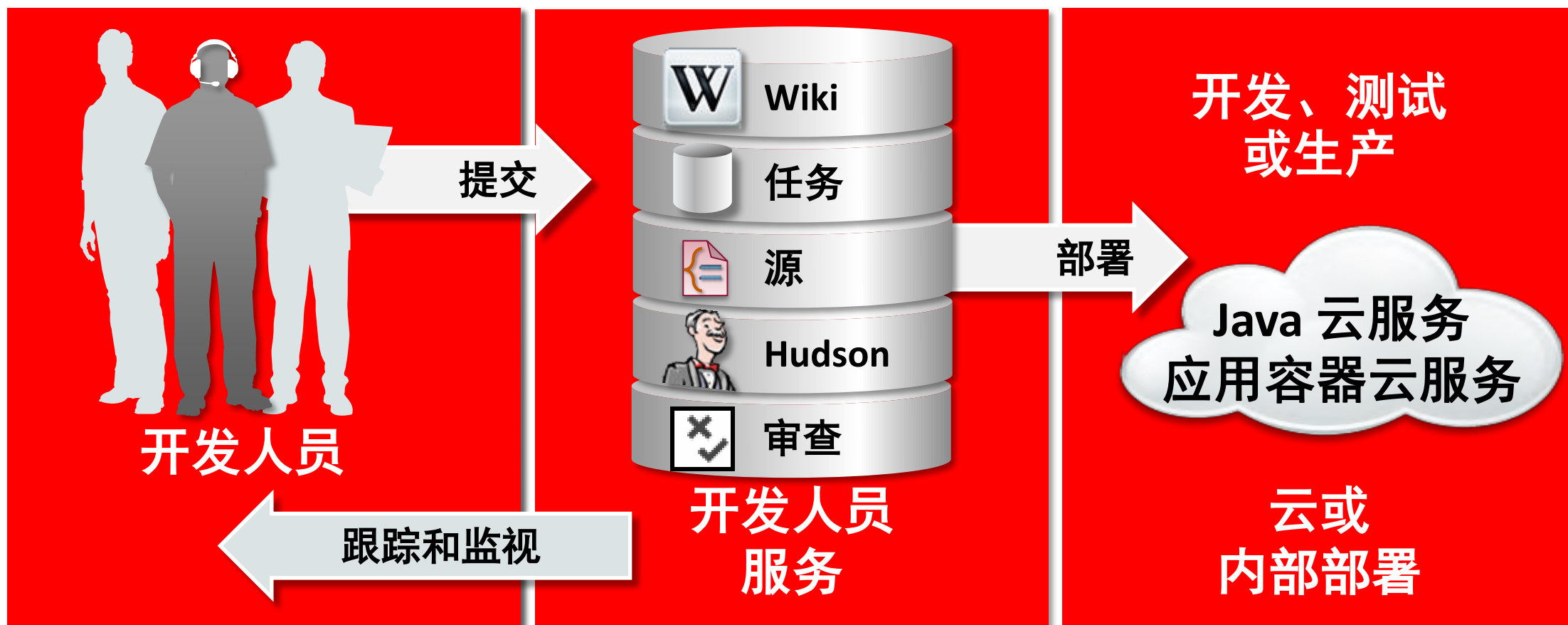

管理您的项目

- 活动流
- Git 信息库
- Maven 信息库
- 团队成员

The screenshot displays the Oracle Developer Cloud Service interface for a project named 'contacts'. The top navigation bar includes 'Home', 'Code', 'Merge Requests', 'Issues', 'Develop', 'Build', 'Deploy', 'Wiki', and 'Administration'. The main content area is divided into two columns. The left column shows a 'TUESDAY, APRIL 14' activity stream with two successful deployment events and three merge request comments. The right column shows a 'REPOSITORIES' section with a '+ New Repository' button and a list of repositories including 'contacts.git' and 'hw.git', each with HTTP and SSH URLs. A 'Maven' section below lists Maven repository URLs.

用 Git 管理代码版本

- 自动供应
- 通过任意 IDE 连接
- 可接入命令行
- 与 GitHub 集成

The screenshot displays the Oracle Developer Cloud Service interface for a repository named 'contacts.git'. The top navigation bar includes 'Home', 'Code', 'Merge Requests', 'Issues', 'Develop', 'Build', 'Deploy', 'Wiki', and 'Administration'. A search bar labeled 'Search Code' is present in the top right. Below the navigation, the repository name 'contacts.git' and a 'NewBranch' button are visible. A context menu is open, showing options for 'Branch' (Create, Rename, Delete) and 'Tag' (Create, Rename, Delete). Below the menu, there are 'HTTP' and 'SSH' buttons, with the SSH URL 'http://alex.admin@ucf2c-dcs-callahan-hub1.' displayed. The main content area shows a file tree with the following items:

File/Folder	Commit Info	Timestamp
.settings	Initial Commit Alex	2015 12:36 AM -0500
src / main	Removed the method Don	2015 1:55 AM -0500
.gitignore	Initial Commit Alex	January 12, 2015 12:36 AM -0500
nb-configuration.xml	Initial Commit Alex	January 12, 2015 12:36 AM -0500
pom.xml	Initial Commit Alex	January 12, 2015 12:36 AM -0500

审查同事的代码

- 创建代码审查
- 邀请团队成员
- 开展审查协作
- 接受/拒绝/重新审查
- 评论代码
- 合并代码
- 解决合并冲突

ORACLE Developer Cloud Service alex.admin

Contacts Search Requests

Home Code Merge Requests Issues Develop Build Deploy Wiki Administration

Merge Requests

Standard Searches My Requests

- All Open Requests
- My Requests**
- Assigned To Me
- Completed
- Closed

ID	Summary	Status
21	Sample merge request	OPEN
3	Review the code	COMPLETED

Page 1 (0-0) 1

Sample merge request

OPEN Alex Admin wants to merge 0+ commits to master from 006

Merge Request

The Branch for this Request (006) will be merged into the target Branch (master).

- Close after merge is complete
- Squash commits

Write Preview Markdown Reference

Merge to master

OK Cancel

跟踪项目问题

- 跟踪需求/错误/ER
- 分配给团队成员
- 在 IDE 中与 MyLyn 集成

The image shows two screenshots illustrating the integration of Oracle Developer Cloud Service (OAS) with Eclipse IDE for tracking project issues.

Top Screenshot: Oracle Developer Cloud Service 'Track Issues' Page

- Header:** ORACLE Developer Cloud Service, alex.admin
- Navigation:** Home, Code, Merge Requests, Issues (selected), Develop, Build, Deploy, Wiki, Administration
- Search:** Search Issues
- Section:** Track Issues
- Advanced Searches:** Recently changed
- Standard Searches:** All issues, Assigned to me, Open issues, Recently changed (highlighted), Related to me
- My Searches:** (Empty)
- Table:** A table with columns: ID, Summary, Component, Status, Owner. It lists 3 items with IDs 41, 2, and 1.
- Page Info:** Page size 20, Page 1 of 1 (1-3 of 3 items)
- Buttons:** New Issue

Bottom Screenshot: Eclipse IDE 'Problem View'

- Outline:** Mine [qa-dev [Contacts]]
- Task List:** 61: Create a Project Tracking Wiki
- Unmatched:** 41: Create web methods for CRUD

The red arrow points from the 'Recently changed' search filter in the OAS interface to the 'Problem View' in Eclipse, indicating the integration of the two systems.

Eclipse 问题视图 →

自动构建项目

- Maven
- Ant
- 基于事件自动执行
— 代码签入

Build Triggers
Trigger a build:
 When these jobs are built
 Based on remote trigger
 Based on this schedule
 Based on SCM polling schedule
 When Maven dependencies have been updated by Maven 3 integration

Build Environment
 Start Xvfb before the build, and shut it down after
 Abort the build if it's stuck

Build
Build steps

Invoke Ant

Targets: deploy

Build File: build.xml

Properties:

Add Build Step

- Execute shell
- Invoke Ant
- Invoke Maven 2 (Legacy)
- Invoke Maven 3

ORACLE Developer Cloud Service shay.shmeltzer@oracle.com

BasicADF Search Not Available

Home Code Merge Requests Issues Build Deploy Wiki Administration

< Jobs Overview ADFSsampleBuild Build Now Configure Disable Delete

Description
No description available

Permalinks
Last | Successful | Failed | Completed | Unsuccessful | Stable

Notifications On Off CC me

Build History

Status	Build	Time	Duration	Console
✓	#8	Yesterday at 7:36 PM -0700	40 s 139 ms	>
✓	#7	February 20 2015 2:15 PM -0800	53 s 286 ms	>
✓	#6	February 5 2015 2:37 PM -0800	52 s 772 ms	>
✓	#5	February 5 2015 2:32 PM -0800	34 s 688 ms	>
✗	#4	January 30 2015 2:35 PM -0800	34 s 351 ms	>
✗	#3	January 30 2015 2:30 PM -0800	31 s 128 ms	>
✗	#2	January 30 2015 12:08 PM -0800	33 s 210 ms	>

Artifacts of Last Successful Build
ojdeploy-build.xml
ojdeploy-statuslog.xml
sampleADF_ViewController_webapp1.war
(all files in zip)

Build Trend
Build duration in seconds
Success Failure

使用 Hudson 实现持续集成

- 按作业查看构建状态
- 创建新作业
- 查看构建历史
- 保存视图
- 执行人员活动视图

The screenshot displays the Oracle Developer Cloud Service interface for Hudson. At the top, it shows the Oracle logo and 'Developer Cloud Service' with the user 'alex.admin'. Below this is a navigation bar with 'Contacts' and a search box. The main navigation menu includes 'Home', 'Code', 'Merge Requests', 'Issues', 'Develop', 'Build' (selected), 'Deploy', 'Wiki', and 'Administration'. The 'Jobs Overview' section features a 'Build Queue' area with a 'View Build History' link and a 'Job Statistics' pie chart showing 50.00% Success (green) and 50.00% Pending (yellow). Below the statistics are filter buttons for 'New Job', 'All Jobs' (selected), 'All Successful Jobs', 'All Failed Jobs', and 'All Unstable Jobs'. A table lists the jobs with columns for Status, Weather, Job, Last Success, Last Failure, Duration, and Actions.

Status	Weather	Job	Last Success	Last Failure	Duration	Actions
✓	☀️	hw	January 21, 2015 12:42 AM -0500	N/A	1 min 38 s	🔍 ⚙️ 📧
🕒		Sample_Maven_Build	N/A	N/A	N/A	🔍 ⚙️ 📧

简化的应用部署

- 创建部署配置
- 开始/停止部署
- 重新部署应用/取消应用部署
- 在云中部署或内部部署

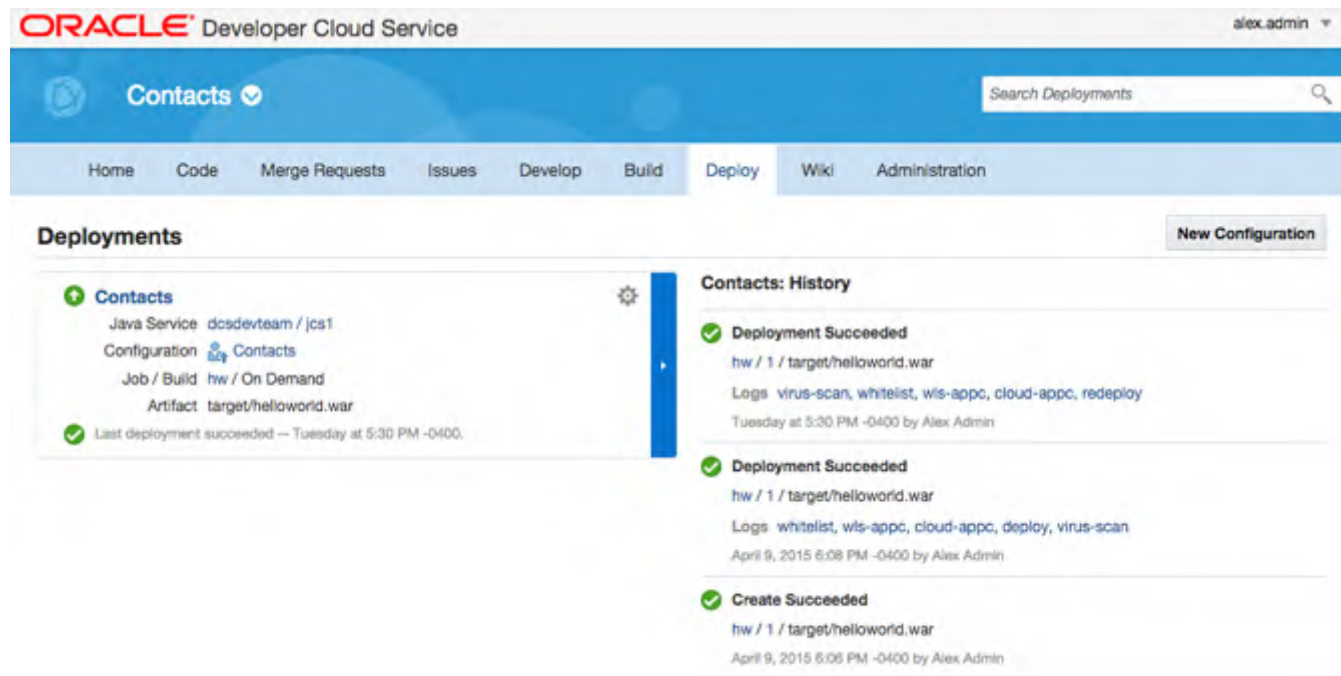

The screenshot displays the Oracle Developer Cloud Service interface. At the top, the Oracle logo and "Developer Cloud Service" are visible, along with the user name "alex.admin". The main navigation bar includes "Contacts" and a search box for "Search Deployments". Below this, a secondary navigation bar contains links for "Home", "Code", "Merge Requests", "Issues", "Develop", "Build", "Deploy", "Wiki", and "Administration". The "Deployments" section is active, showing a "New Configuration" button. The "Contacts" section lists a Java Service named "dcsdevteam / jcs1" with configuration details: "Configuration: Contacts", "Job / Build: hw / On Demand", and "Artifact: target/helloworld.war". A status message indicates "Last deployment succeeded — Tuesday at 5:30 PM -0400". The "Contacts: History" section shows three successful events: "Deployment Succeeded" (Tuesday at 5:30 PM -0400 by Alex Admin), "Deployment Succeeded" (April 9, 2015 6:08 PM -0400 by Alex Admin), and "Create Succeeded" (April 9, 2015 6:06 PM -0400 by Alex Admin).

通过 Wiki 分享信息

- 创建新的项目 wiki
- 通过针对特定项目的 wiki 协作
- 内容管理
- 可以选择使用 wiki 标记

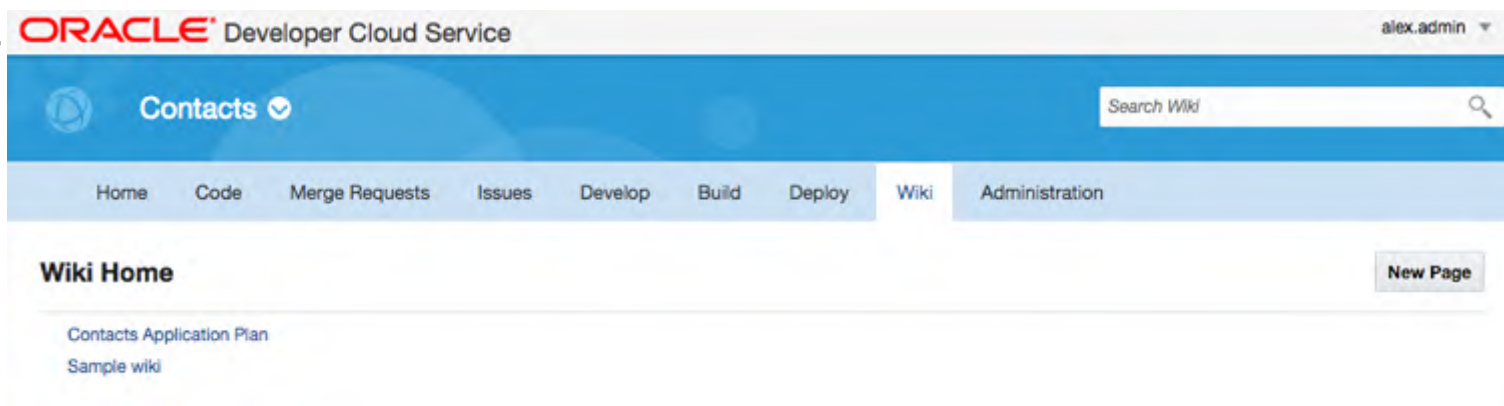

管理您的项目

- 管理项目属性
- 分析使用情况数据
- 定制问题跟踪
- 配置 Git 信息库
 - 托管、外部
- 管理分支
 - 管理员与限制
- 创建与外部 Web 服务的连接
- 与联合服务连接

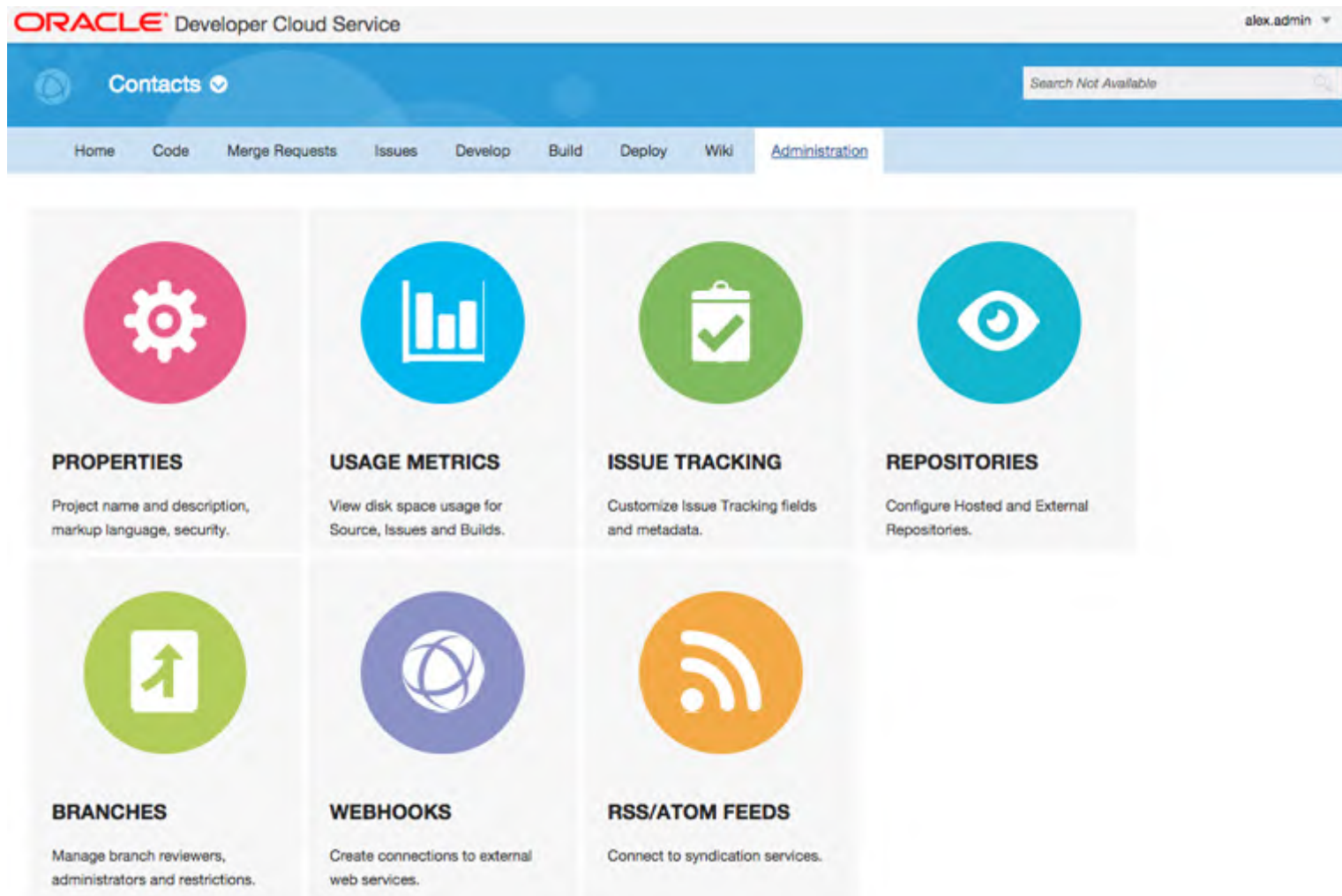

ORACLE Developer Cloud Service alex.admin

Contacts

Search Not Available

Home Code Merge Requests Issues Develop Build Deploy Wiki Administration

PROPERTIES
Project name and description, markup language, security.

USAGE METRICS
View disk space usage for Source, Issues and Builds.

ISSUE TRACKING
Customize Issue Tracking fields and metadata.

REPOSITORIES
Configure Hosted and External Repositories.

BRANCHES
Manage branch reviewers, administrators and restrictions.

WEBHOOKS
Create connections to external web services.

RSS/ATOM FEEDS
Connect to syndication services.

面向 DevOps 文化的集成的 Oracle 云服务

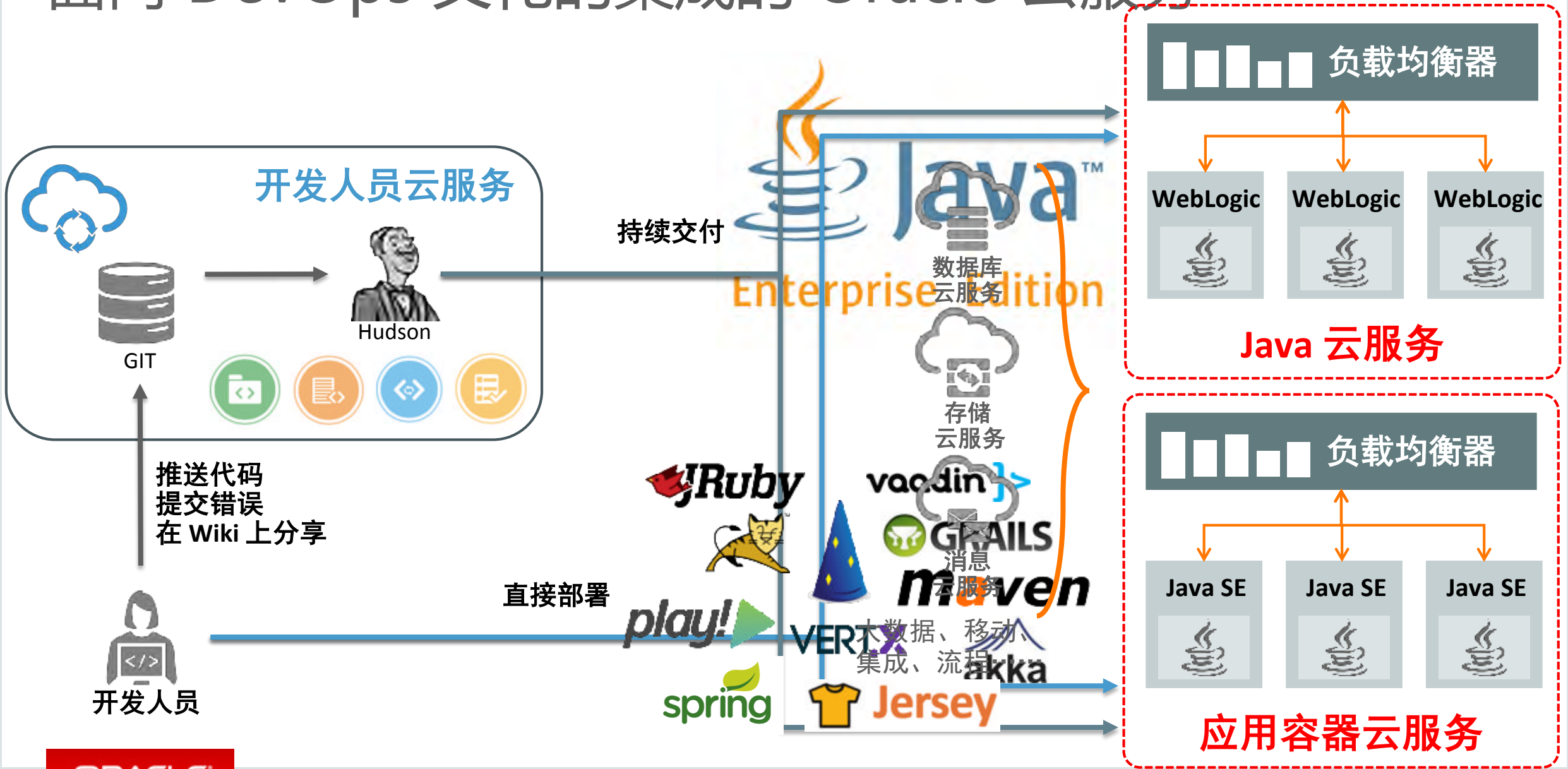

甲骨文应用性能监控云服务

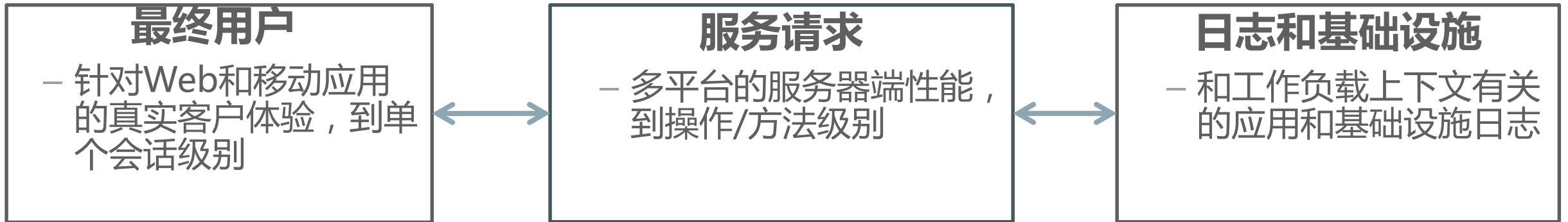

无需配置、弹性应用模型、REST API、阈值

应用性能监控云服务支持本地和云的负载监控

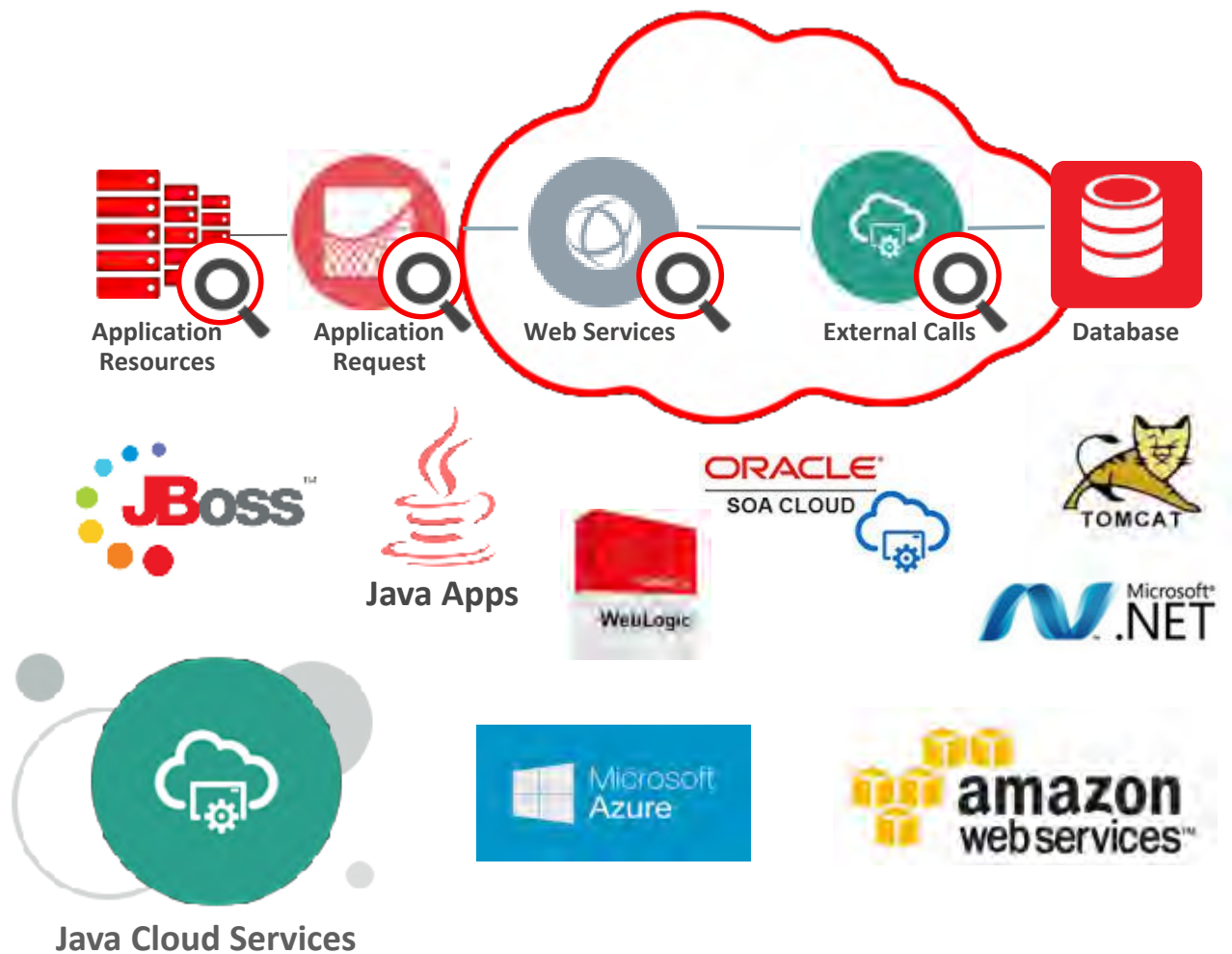

- 轻量的
- 快速部署
- 可以随着应用规模而扩展到任何级别
- 零成本配置



- 识别在云中或本地部署的应用问题
- 可视化分析远程或本地的性能或系统日志



演示

Oracle DevOps解决方案



SIGN IN TO ORACLE CLOUD

Enter your Identity Domain

Remember my choice [?](#)

Go

ORACLE®



SIGN IN TO ORACLE CLOUD

Welcome **usoracle21884** [change domain](#) [?](#)

[Can't access your account?](#)

Sign In

ORACLE



SIGN IN TO ORACLE CLOUD

Welcome **usoracle21884** [change domain](#) [?](#)

[Can't access your account?](#)

Sign In

ORACLE

Dashboard

Customize Dashboard 8



CLOUD SERVICES Identity Domain usoracle21884

Create Instance

1 Important Notifications

Compute
1.5 of 6 OCPU_GP
Remaining

Storage
72.524 of 250 Standard ...
Remaining

Compute
3 of 6 EIPs
Remaining

Developer20024
Developer

⊕ ⚙ ☰
☁️ ✓

Java
Instance ①

⊕ ⚙ ☰
☁️ ✓

Application Container
Instances ③

⊕ ⚙ ☰
☁️ ✓

Database
Instances ②

⊕ ⚙ ☰
☁️ ✓

Compute
Instances ③

⊕ ⚙ ☰
☁️ ✓

SOA

⊕ ⚙ ☰
☁️ ✓

Dashboard

Customize Dashboard 8 ?

CLOUD SERVICES Identity Domain usoracle21884

Create Instance

1 Important Notifications

Compute
1.5 of 6 OCPU_GP
Remaining

Storage
72.524 of 250 Standard ...
Remaining

Compute
3 of 6 EIPs
Remaining

Developer20024
Developer

⊕ ⚙ ⋮

☁️ ✓

Java

⊕ ⚙ ⋮

☁️ ✓

Application Container

Instances ③

⊕ ⚙ ⋮

☁️ ✓

Database

Instances ②

⊕ ⚙ ⋮

☁️ ✓

Compute

Instances ③

⊕ ⚙ ⋮

☁️ ✓

SOA

⊕ ⚙ ⋮

☁️ ✓

View Details

Open Service Console



Select an existing project or create a new one.

Member Favorites **Owner** All + New Project

Filter Projects 

daytrader 
Java EE application for JCS

SpringBoot 
No description

Enabling Continuous Delivery for SOA Compos...

Learn how to automate SOA composite builds and deployments with Developer and SOA Cloud Services.



daytrader

Search Activities

JANUARY 2017

Build **22** of job **DayTrader_Tests** ended:
 Result: Success Duration: 2 min 30 s
 January 3, 2017 3:42 PM +0800

Deployed **daytrader** at weblogic@129.152.129.93:9001
 Build: **DayTrader_Build/#22** Artifact: **daytrader-master/javaee6/modules/web/target/web-3.0.0.war**
 January 3, 2017 3:39 PM +0800

Build **22** of job **DayTrader_Build** ended:
 Result: Success Duration: 1 min 39 s
 January 3, 2017 3:39 PM +0800

DECEMBER 2016

Build **21** of job **DayTrader_Tests** ended:
 Result: Success Duration: 2 min 27 s
 December 10, 2016 10:33 PM +0800

Deployed **daytrader** at weblogic@129.152.129.93:9001
 Build: **DayTrader_Build/#21** Artifact: **daytrader-master/javaee6/modules/web/target/web-3.0.0.war**
 December 10, 2016 10:30 PM +0800

Build **21** of job **DayTrader_Build** ended:
 Result: Success Duration: 1 min 11 s
 December 10, 2016 10:30 PM +0800

Cloud Admin pushed **7eadfa26** (by Kwan@192.168.0.3) to **master** in **daytrader.git**
 Changed background colour to white
 December 10, 2016 10:28 PM +0800

Build **20** of job **DayTrader_Tests** ended:
 Result: Success Duration: 2 min 7 s
 December 10, 2016 10:26 PM +0800

Using DevCS with Oracle Database and APEX

Learn how to use DevCS version control and continuous integration for APEX applications.

REPOSITORIES + New Repository

Filter Git Repositories

All Favorites Favorites First

daytrader.git

HTTP SSH <https://cloud.admin@developer.us2.oraclecloud.com/de>

Maven

HTTP DAV <https://developer.us2.oraclecloud.com/profile/develop>

daytrader

Search Code

daytrader.git master

Files Commits Graph Branches Tags Compare

Description HTTP SSH *Click to add description of this repository.*

daytrader-master	Changed background colour to white Kwan	December 10, 2016 10:28 PM +0800
daytrader-tests-master	Initial load Kwan	October 21, 2016 9:18 PM +0800
daytrader-wlst-master	Initial load Kwan	October 21, 2016 9:18 PM +0800
README.md	Initial Commit for daytrader.git SYSTEM	October 21, 2016 4:44 PM +0800

README.md

daytrader.git



CanDo Demo

Search Not Available



Microservices for Stock Quote

Backlog

Active Sprints

Reports

Board

+ New Sprint

▲ Sprint 1 - Initial Development 6 issues

Edit Sprint...

3/15/2017 4:20 PM • 4/1/2017 4:20 PM

7 2 9

🚩	!!	Task 7	Create Initial User Registry For Testing	Roland Dub...	2
🚩	!!	Defect 6	User Login Failure		1
🚩	!!	Feature 4	Display exception when quote is greater than the Quote Return Array Index	John Dunbar	2
🚩	!!	Task 3	Create Initial GIT Repository for Stock Quote UI	John Dunbar	1
🚩	!!	Feature-2	Create Filter for Stock Quote feed	Bala Gupta	2
🚩	!!	Task 1	Create Initial GIT Repository for Stock Quote	Bala Gupta	1

New Issue

Backlog 1 issue

🚩	!!	Feature 5	Display User's Transaction History on Account Dashboard	Roland Dub...	2
---	----	-----------	---------------------------------------------------------	---------------	---

CanDo Demo

Search Not Available

Microservices for Stock Quote

Backlog

Active Sprints

Reports

Board

Sprint: Sprint 1 - Initial Development -- 3/15/2017 4:20 PM • 4/1/2017 4:20 PM

Complete Sprint

Swimlanes

Columns

Sort Issues by: Priority

Sort Swimlanes by: User Name

To Do (1)

1

In Progress (3)

5

Verify Code (1)

1

Completed (1)

2

bala.gupta

Task 1
Create Initial GIT Reposito...

1

ASSIGNED

Feature 2
Create Filter for Stock Qu...

2

VERIFIED : FIXED

john.dunbar

Feature 4
Display exception when q...

2

REOPENED

Task 3
Create Initial GIT Reposito...

1

RESOLVED : FIXED

roland.dubois



CanDo Demo

Search Not Available

Microservices for Stock Quote

Backlog

Active Sprints

Reports

Board

Sprint Sprint 1 - Initial Development

Burndown Story Points

Burndown Chart

Sprint Report

Total Story Points for remaining Open Issues after each event

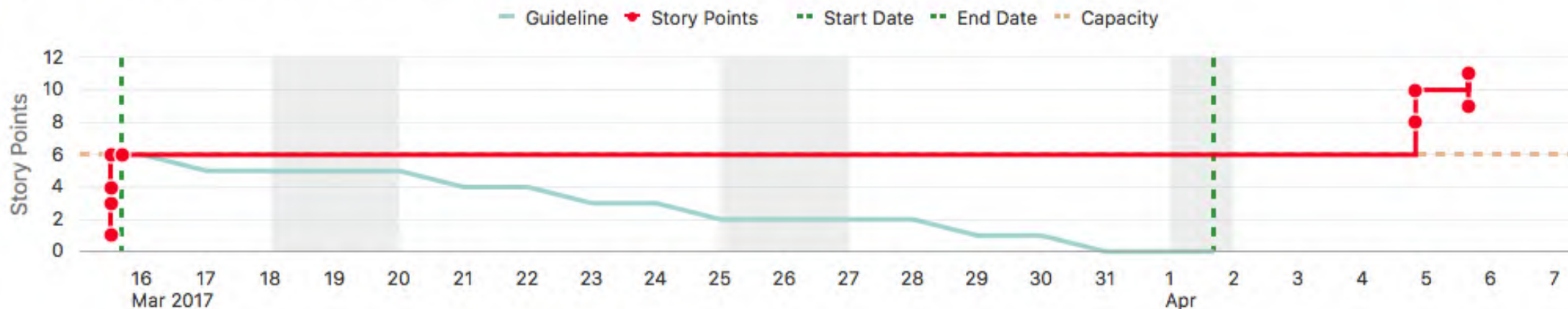

Active sprint owned by Cloud Admin in board **Microservices for Stock Quote** and using search **ALL** from board **Microservices for Stock Quote**

Start Date 3/15/2017 4:20 PM to End Date 4/1/2017 4:20 PM (17 days)

Number of working days in sprint: 12 days, 7 hours, 40 minutes

Jobs Overview

Build Queue

[View Build History](#)

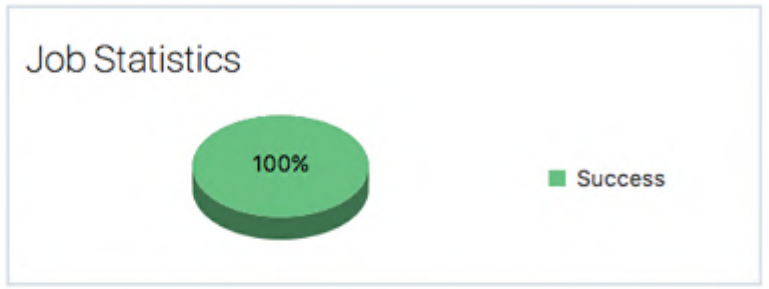

[+ New Job](#) [All Jobs](#) [All Successful Jobs](#) [All Failed Jobs](#) [All Unstable Jobs](#)

Status	Weather	Job	Last Success	Last Failure	Duration	Actions
✓	☀	DayTrader_Build	January 3, 2017 3:37 PM +0800	N/A	1 min 39 s	▶ 📄 🔧
✓	☀	DayTrader_Tests	January 3, 2017 3:40 PM +0800	N/A	2 min 30 s	▶ 📄 🔧

Deployments

+ New Configuration

daytrader

Deploy to JCS [129.152.129.93 / 7002 / weblogic / daytrade_cluster](#)

Configuration [Deploy2daytraderWLS](#)

Job / Build [DayTrader_Build / Latest Successful Build](#)

Artifact [daytrader-master/javaee6/modules/web/target/web-3.0.0.war](#)

✓ Last deployment succeeded -- January 3, 2017 3:39 PM +0800.

Deploy2daytraderWLS: History

- ✓ **Deployment Succeeded**
[DayTrader_Build / 22 / daytrader-master/javaee6/modules/web/target/web-3.0.0.war](#)
Logs [dcs_undeploy](#), [dcs_deploy](#)
January 3, 2017 3:39 PM +0800
- ✓ **Deployment Succeeded**
[DayTrader_Build / 21 / daytrader-master/javaee6/modules/web/target/web-3.0.0.war](#)
Logs [dcs_undeploy](#), [dcs_deploy](#)
December 10, 2016 10:30 PM +0800
- ✓ **Deployment Succeeded**
[DayTrader_Build / 20 / daytrader-master/javaee6/modules/web/target/web-3.0.0.war](#)
Logs [dcs_undeploy](#), [dcs_deploy](#)
December 10, 2016 10:23 PM +0800
- ✓ **Deployment Succeeded**
[DayTrader_Build / 19 / daytrader-master/javaee6/modules/web/target/web-3.0.0.war](#)
Logs [dcs_undeploy](#), [dcs_deploy](#)
December 10, 2016 10:19 PM +0800
- ✓ **Deployment Succeeded**
[DayTrader_Build / 18 / daytrader-master/javaee6/modules/web/target/web-3.0.0.war](#)
Logs [dcs_undeploy](#), [dcs_deploy](#)
December 10, 2016 10:13 PM +0800
- ✓ **Deployment Succeeded**
[DayTrader_Build / 17 / daytrader-master/javaee6/modules/web/target/web-3.0.0.war](#)
Logs [dcs_undeploy](#), [dcs_deploy](#)
December 10, 2016 10:10 PM +0800 by Cloud Admin

Track Issues

Advanced Searches

Standard Searches

- All issues
- Assigned to me
- Open issues
- Recently changed**
- Related to me

My Searches

Recently changed

Page size

!	!	ID	Summary	Component	Status	Owner	Cre
		41	Wrong background home page	Default	Assigned		11/
		22	Wrong background colour in home page	Default	Resolved		10,
		4	Create new branch for feature enhancement	Default	Assigned	Roland Dubois	10,
		11	Deploy DayTrader app	Default	Assigned	Cloud Admin	10,
		8	Update POM dependency	Default	Assigned	Roland Dubois	10,
		7	Add Maven POM support	Default	Resolved	Bala Gupta	10,
		20	Change to Maven 3 support	Default	Unconfirmed	Bala Gupta	10,
		19	Provision additional managed server in JCS	Default	Unconfirmed	Cloud Admin	10,
		3	User login failure	Default	Resolved	Lisa Jones	10,
		14	Create build job	Default	New	Bala Gupta	10,
		18	Broken link to configuration tab	Default	Assigned	Lisa Jones	10,
		17	Upgrade Java 8u66	Default	New	Cloud Admin	10,

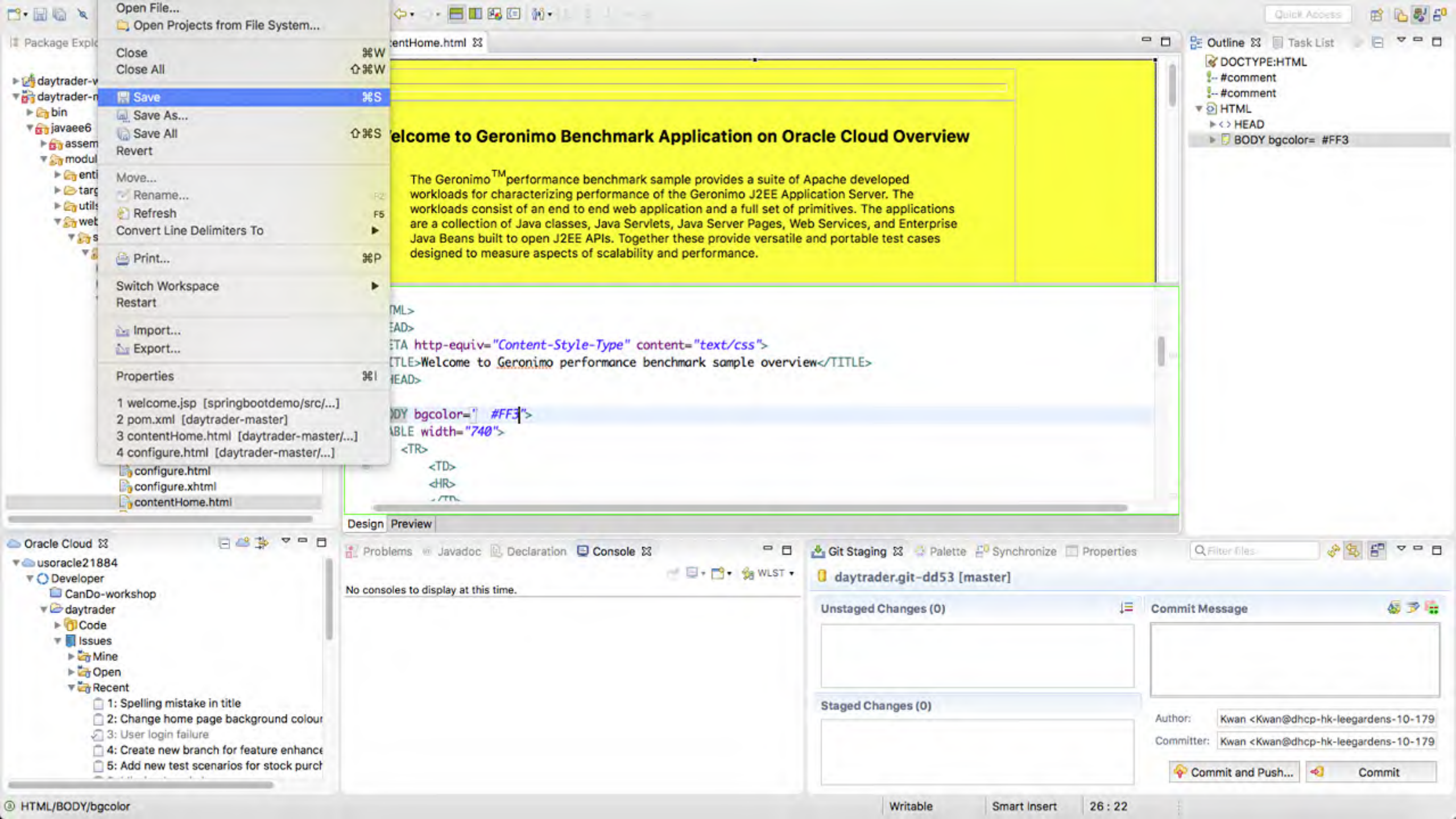

Package Explorer Project Explorer

- daytrader-wlst-master [daytrader.git-dd53 master]
- daytrader-master [daytrader.git-dd53 master]
- bin
- javaee6
- assemblies
- modules
- entities
- target
- utils
- web
- src
- main
- java
- resources
- webapp
- dbscripts
- docs
- images
- META-INF
- WEB-INF
- account.jsp
- account.xhtml
- accountImg.jsp
- config.jsp
- config.xhtml
- configure.html
- configure.xhtml
- contentHome.html

contentHome.html

Welcome to Geronimo Benchmark Application on Oracle Cloud Overview

The Geronimo™ performance benchmark sample provides a suite of Apache developed workloads for characterizing performance of the Geronimo J2EE Application Server. The workloads consist of an end to end web application and a full set of primitives. The applications are a collection of Java classes, Java Servlets, Java Server Pages, Web Services, and Enterprise Java Beans built to open J2EE APIs. Together these provide versatile and portable test cases designed to measure aspects of scalability and performance.

```
<HTML>
<HEAD>
<META http-equiv="Content-Style-Type" content="text/css">
<TITLE>Welcome to Geronimo performance benchmark sample overview</TITLE>
</HEAD>
<BODY bgcolor=" #FF3">
<TABLE width="740">
<TR>
<TD>
<HR>
</TR>
</TABLE>
</BODY>
</HTML>
```

Outline Task List

- DOCTYPE:HTML
- #comment
- #comment
- HTML
- <> HEAD
- BODY bgcolor= #FF3

Oracle Cloud

- usoracle21884
- Developer
- CanDo-workshop
- daytrader
- Code
- Issues
- Mine
- Open
- Recent
- 1: Spelling mistake in title
- 2: Change home page background colour
- 3: User login failure
- 4: Create new branch for feature enhance
- 5: Add new test scenarios for stock purch

Problems Javadoc Declaration Console

No consoles to display at this time.

Git Staging Palette Synchronize Properties

Filter files

> daytrader.git-dd53 [master]

Open WLST Console

Staged Changes (1)

- > contentHome.html - daytrader-master/javaee6/mod

Staged Changes (0)

Commit Message

Author: Kwan <Kwan@dhcp-hk-leegardens-10-179>

Committer: Kwan <Kwan@dhcp-hk-leegardens-10-179>

Commit and Push... Commit

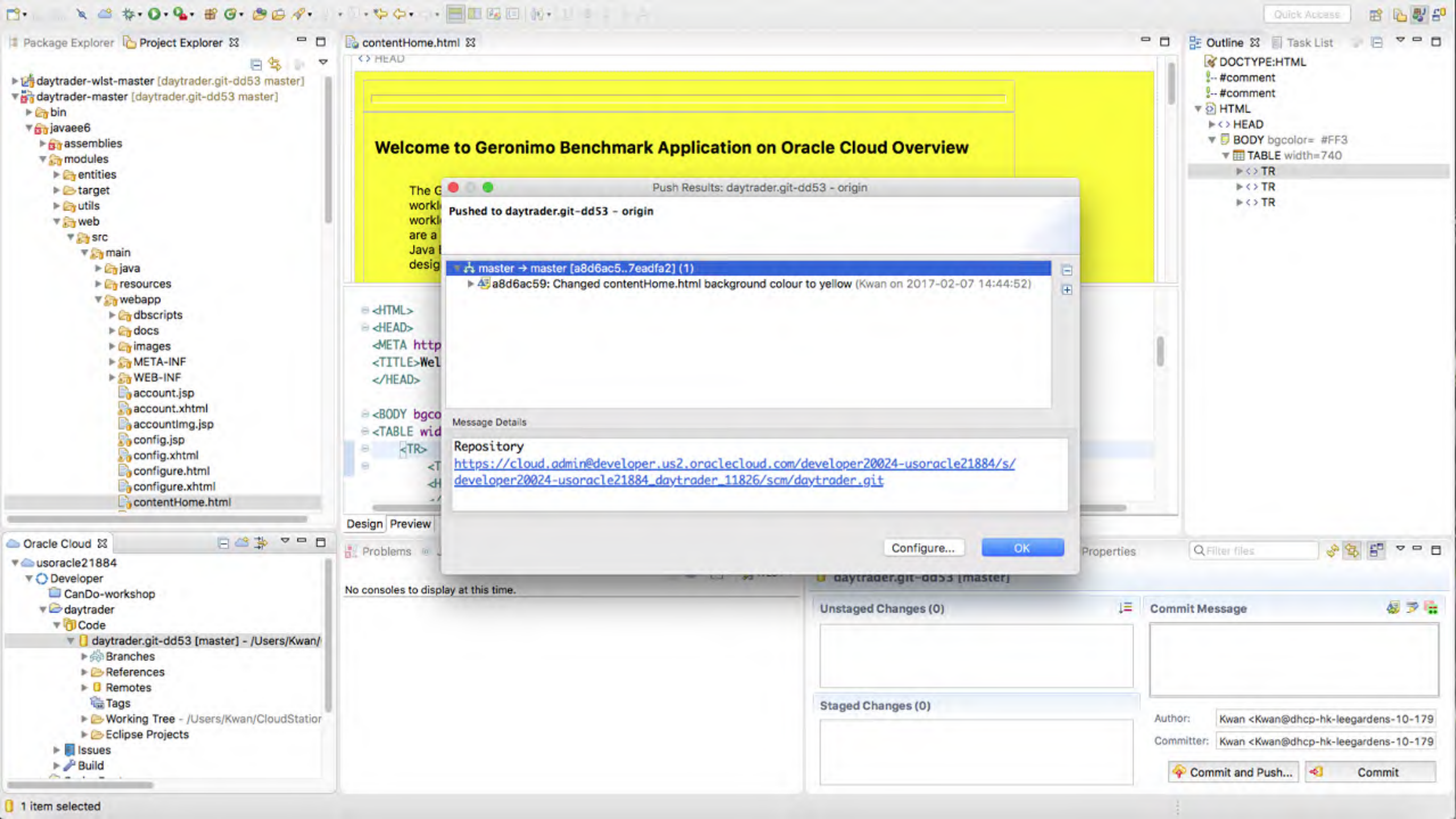

Package Explorer Project Explorer

- daytrader-wlst-master [daytrader.git-dd53 master]
- daytrader-master [daytrader.git-dd53 master]
 - bin
 - javaee6
 - assemblies
 - modules
 - entities
 - target
 - utils
 - web
 - src
 - main
 - java
 - resources
 - webapp
 - dbscripts
 - docs
 - images
 - META-INF
 - WEB-INF
 - account.jsp
 - account.xhtml
 - accountImg.jsp
 - config.jsp
 - config.xhtml
 - configure.html
 - configure.xhtml
 - contentHome.html

contentHome.html

```
<> HEAD
```

Welcome to Geronimo Benchmark Application on Oracle Cloud Overview

The Geronimo workbench workbench are a Java design

```

<HTML>
<HEAD>
<META http-equiv="Content-Type" content="text/html; charset=UTF-8">
<TITLE>Welcome to Geronimo Benchmark Application on Oracle Cloud Overview</TITLE>
</HEAD>
<BODY bgcolor=#FF3333>
<TABLE width=740>
<TR>
<TR>
<TR>
</TR>
</TABLE>
</BODY>
</HTML>

```

Outline Task List

- DOCTYPE:HTML
- #comment
- #comment
- HTML
 - <> HEAD
 - BODY bgcolor= #FF3
 - TABLE width=740
 - <> TR
 - <> TR
 - <> TR

Push Results: daytrader.git-dd53 - origin

Pushed to daytrader.git-dd53 - origin

- master → master [a8d6ac5..7eadfa2] (1)
 - a8d6ac59: Changed contentHome.html background colour to yellow (Kwan on 2017-02-07 14:44:52)

Message Details

Repository
https://cloud.admin@developer.us2.oraclecloud.com/developer20024-usoracle21884/s/developer20024-usoracle21884_daytrader_11826/scm/daytrader.git

Configure... OK

Oracle Cloud

- usoracle21884
 - Developer
 - CanDo-workshop
 - daytrader
 - Code
 - daytrader.git-dd53 [master] - /Users/Kwan/
 - Branches
 - References
 - Remotes
 - Tags
 - Working Tree - /Users/Kwan/CloudStator
 - Eclipse Projects
 - Issues
 - Build

Design Preview

Problems

No consoles to display at this time.

daytrader.git-dd53 [master]

Unstaged Changes (0)

Staged Changes (0)

Commit Message

Author: Kwan <Kwan@dhcp-hk-leegardens-10-179>
 Committer: Kwan <Kwan@dhcp-hk-leegardens-10-179>

Commit and Push... Commit

NOW RUNNING

 Build **23** of job **DayTrader_Build** is running Just now

TODAY

 **Cloud Admin** pushed `a8d6ac59` (by `Kwan@dhcp-hk-leegardens-10-179-249-111.hk.oracle.com`) to **master** in **daytrader.git**

`Changed contentHome.html background colour to yellow` Just now

JANUARY 2017 February 7, 2017 2:46 PM +0800

 Build **22** of job **DayTrader_Tests** ended:
Result: **Success** Duration: 2 min 30 s January 3, 2017 3:42 PM +0800

 Deployed **daytrader** at `weblogic@129.152.129.93:9001`
Build: `DayTrader_Build/#22` Artifact: `daytrader-master/javaee6/modules/web/target/web-3.0.0.war` January 3, 2017 3:39 PM +0800

 Build **22** of job **DayTrader_Build** ended:
Result: **Success** Duration: 1 min 39 s January 3, 2017 3:39 PM +0800

DECEMBER 2016

 Build **21** of job **DayTrader_Tests** ended:
Result: **Success** Duration: 2 min 27 s December 10, 2016 10:33 PM +0800

 Deployed **daytrader** at `weblogic@129.152.129.93:9001`
Build: `DayTrader_Build/#21` Artifact: `daytrader-master/javaee6/modules/web/target/web-3.0.0.war` December 10, 2016 10:30 PM +0800

Enabling Continuous Delivery for SOA Comp... ✕

Learn how to automate SOA composite builds and deployments with Developer and SOA Cloud Services.

REPOSITORIES + New Repository

Filter Git Repositories 🔍

All Favorites Favorites First ▾

daytrader.git ☆

HTTP SSH `https://cloud.admin@developer.us2.oraclecloud.com/de`

Maven

HTTP DAV `https://developer.us2.oraclecloud.com/profile/develop`

Jobs Overview

Build Queue
DayTrader_Build

88%

[View Build History](#)

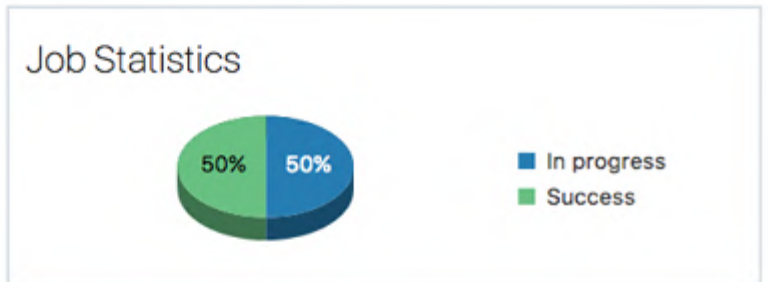

[+ New Job](#)
[All Jobs](#)
[All Successful Jobs](#)
[All Failed Jobs](#)
[All Unstable Jobs](#)

Status	Weather	Job	Last Success	Last Failure	Duration	Actions
		DayTrader_Build	January 3, 2017 3:37 PM +0800	N/A	1 min 39 s	
		DayTrader_Tests	January 3, 2017 3:40 PM +0800	N/A	2 min 30 s	

Jobs Overview

Build Queue
DayTrader_Tests Queued

[View Build History](#)

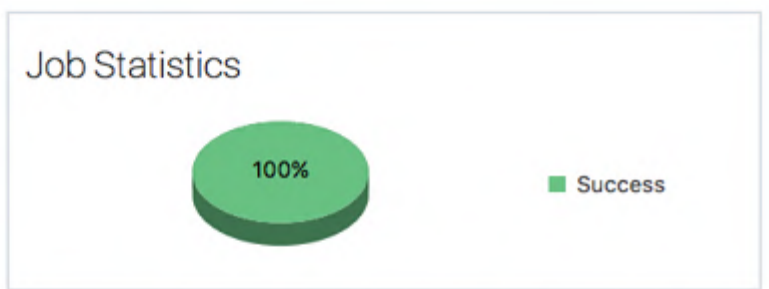

[+ New Job](#)
[All Jobs](#)
[All Successful Jobs](#)
[All Failed Jobs](#)
[All Unstable Jobs](#)

Status	Weather	Job	Last Success	Last Failure	Duration	Actions
✓	☀️	DayTrader_Build	Just now	N/A	1 min 30 s	🔍 📄 🔄
✓	☀️	DayTrader_Tests	January 3, 2017 3:40 PM +0800	N/A	2 min 30 s	🔍 📄 🔄

Deployments

daytrader

Deploy to JCS 129.152.129.93 / 7002 / weblogic / daytrade_cluster
Configuration [Deploy2daytraderWLS](#)
Job / Build [DayTrader_Build / Latest Successful Build](#)
Artifact [daytrader-master/javaee6/modules/web/target/web-3.0.0.war](#)

✓ Last deployment succeeded -- Just now.

Deploy2daytraderWLS: History

- ✓ **Deployment Succeeded**
[DayTrader_Build / 27 / daytrader-master/javaee6/modules/web/target/web-3.0.0.war](#)
[Logs](#) [dcs_undeploy](#), [dcs_deploy](#)
[Just now](#) by Cloud Admin
- ✓ **Deployment Succeeded**
[DayTrader_Build / 27 / daytrader-master/javaee6/modules/web/target/web-3.0.0.war](#)
[Logs](#) [dcs_undeploy](#), [dcs_deploy](#)
2 minutes ago by Cloud Admin
- ✓ **Deployment Succeeded**
[DayTrader_Build / 27 / daytrader-master/javaee6/modules/web/target/web-3.0.0.war](#)
[Logs](#) [dcs_undeploy](#), [dcs_deploy](#)
3 minutes ago by Cloud Admin
- ✓ **Deployment Succeeded**
[DayTrader_Build / 27 / daytrader-master/javaee6/modules/web/target/web-3.0.0.war](#)
[Logs](#) [dcs_undeploy](#), [dcs_deploy](#)
6 minutes ago by Cloud Admin
- ✓ **Deployment Succeeded**
[DayTrader_Build / 27 / daytrader-master/javaee6/modules/web/target/web-3.0.0.war](#)
[Logs](#) [dcs_undeploy](#), [dcs_deploy](#)
9 minutes ago by Cloud Admin
- ✓ **Deployment Succeeded**
[DayTrader_Build / 27 / daytrader-master/javaee6/modules/web/target/web-3.0.0.war](#)
[Logs](#) [dcs_undeploy](#), [dcs_deploy](#)
9 minutes ago by Cloud Admin
- ✓ **Deployment Succeeded**
[DayTrader_Build / 27 / daytrader-master/javaee6/modules/web/target/web-3.0.0.war](#)
[Logs](#) [dcs_deploy](#)

Jobs Overview

Build Queue
DayTrader_Tests

 25%

[View Build History](#)



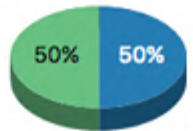





Job Statistics



- In progress
- Success

[+ New Job](#)

[All Jobs](#)
[All Successful Jobs](#)
[All Failed Jobs](#)
[All Unstable Jobs](#)

Status	Weather	Job	Last Success	Last Failure	Duration	Actions
✔		DayTrader_Build	3 minutes ago	N/A	1 min 30 s	  
		DayTrader_Tests	January 3, 2017 3:40 PM +0800	N/A	2 min 30 s	  

Jobs Overview

Build Queue

[View Build History](#)

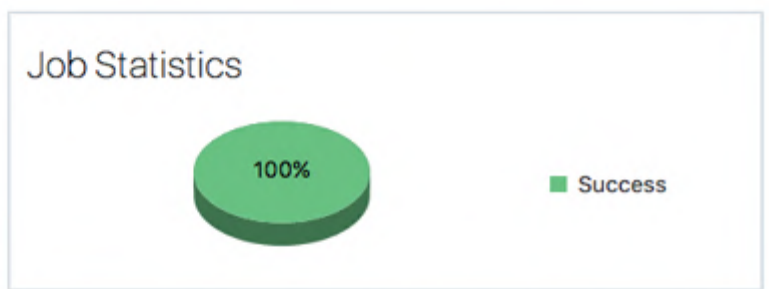

[+ New Job](#) [All Jobs](#) [All Successful Jobs](#) [All Failed Jobs](#) [All Unstable Jobs](#)

Status	Weather	Job	Last Success	Last Failure	Duration	Actions
✓	☀️	DayTrader_Build	4 minutes ago	N/A	1 min 30 s	👉 🏠 🛠️
✓	☀️	DayTrader_Tests	2 minutes ago	N/A	1 min 45 s	👉 🏠 🛠️

Jobs Overview | DayTrader_Tests

Build Now | Configure | Disable | Delete

Description

No description available

Console | Changes | Git Logs | Audit

Artifacts of Last Successful Build

daytrader-tests-master

(all files in zip)

Permalinks

Last | Successful | Failed | Completed | Unsuccessful | Stable | Unstable

Upstream projects

DayTrader_Build

Notifications

On Off CC Me

Build History

Status	Build	Time	Duration	Console
✓	#25	54 minutes ago	2 min 13 s	>
✓	#24	Yesterday at 10:35 AM +0800	2 min	>
✓	#23	Tuesday at 2:49 PM +0800	1 min 45 s	>
✓	#22	January 3, 2017 3:40 PM +0800	2 min 30 s	>
✓	#21	December 10, 2016 10:30 PM +0800	2 min 27 s	>
✓	#20	December 10, 2016 10:24 PM +0800	2 min 7 s	>

Build Trend



Test Result Trend

Jobs Overview | DayTrader_Tests

Build Now | Configure | Disable | Delete

Description

No description available

Console | Changes | Git Logs | Audit

Permalinks

Last | Successful | Failed | Completed

Upstream projects

DayTrader_Build

Notifications

Build History

Opening archive.zip

You have chosen to open:

archive.zip
 which is: Zip Archive
 from: <https://developer.us2.oraclecloud.com>

What should Firefox do with this file?

Open with WinZip (default)

Save File

Do this automatically for files like this from now on.

Artifacts of Last Successful Build

- daytrader-tests-master
- [all files in zip]

Build Trend

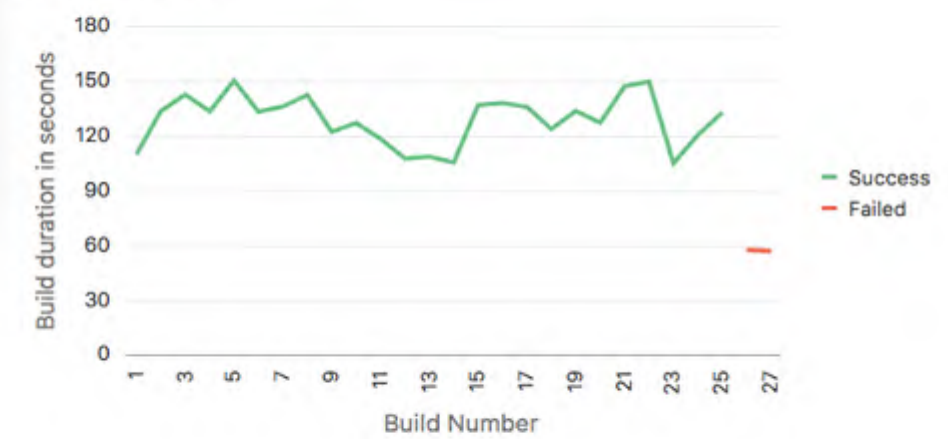

Test Result Trend

Status	Build	Time	Duration	Console
✓	#25	54 minutes ago	2 min 13 s	▶
✓	#24	Yesterday at 10:35 AM +0800	2 min	▶
✓	#23	Tuesday at 2:49 PM +0800	1 min 45 s	▶
✓	#22	January 3, 2017 3:40 PM +0800	2 min 30 s	▶
✓	#21	December 10, 2016 10:30 PM +0800	2 min 27 s	▶
✓	#20	December 10, 2016 10:24 PM +0800	2 min 7 s	▶

- Project
- Code
- Maven
- Snippets
- Merge Requests
- Issues
- Agile
- Build**
- Deploy
- Wiki
- Administration

daytrader

Search Not Available

Build Now Configure Disable Delete

Console Changes Git Logs Audit

archive.zip

View Add Unzip Email Share

site
archive > archive > daytrader-tests-master > target

Unzipped 111 KB 15 files Zipped 21.9 KB 1 Zip file

Name	Date Modified	Unzipped	Zipped	Kind
dependencies.html	9 Feb 2017, 7:00:32 AM	56.3 KB	8.1 KB	HTML text
dependency-convergence.html	9 Feb 2017, 7:00:32 AM	7.9 KB	1.8 KB	HTML text
dependency-info.html	9 Feb 2017, 7:00:32 AM	5.9 KB	1.5 KB	HTML text
distribution-management.html	9 Feb 2017, 7:00:32 AM	4.5 KB	1.2 KB	HTML text
index.html	9 Feb 2017, 7:00:32 AM	4.3 KB	1.1 KB	HTML text
plugin-management.html	9 Feb 2017, 7:00:32 AM	5.1 KB	1.3 KB	HTML text
plugins.html	9 Feb 2017, 7:00:32 AM	6.4 KB	1.4 KB	HTML text
project-info.html	9 Feb 2017, 7:00:32 AM	6.0 KB	1.6 KB	HTML text
project-reports.html	9 Feb 2017, 7:00:32 AM	3.6 KB	1.2 KB	HTML text
project-summary.html	9 Feb 2017, 7:00:32 AM	5.2 KB	1.3 KB	HTML text
surefire-report.html	9 Feb 2017, 7:00:32 AM	5.7 KB	1.5 KB	HTML text

1 of 11 selected, 4.3 KB unzipped, 1.1 KB zipped

Most Successful Build

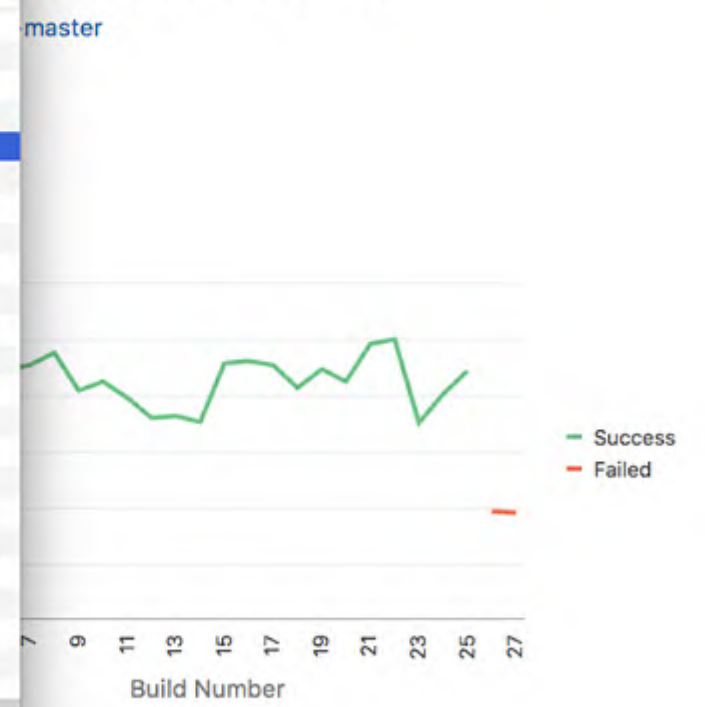

✓	#23	Tuesday at 2:49 PM +0800	1 min 45 s	>
✓	#22	January 3, 2017 3:40 PM +0800	2 min 30 s	>
✓	#21	December 10, 2016 10:30 PM +0800	2 min 27 s	>

Test Result Trend

Project Documentation

- [Project Information](#)
 - [Dependencies](#)
 - [Dependency Convergence](#)
 - [Dependency Information](#)
 - [Distribution Management](#)
 - **About**
 - [Plugin Management](#)
 - [Plugins](#)
 - [Summary](#)
- [Project Reports](#)

[Built by Maven](#)

About tests

There is currently no description associated with this project.

Project Documentation

- [Project Information](#)
- [Project Reports](#)
 - **Surefire Report**

[Built by Maven](#)

Surefire Report

Summary

[\[Summary\]](#) [\[Package List\]](#) [\[Test Cases\]](#)

Tests	Errors	Failures	Skipped	Success Rate	Time
3	0	0	0	100%	33.941

Note: failures are anticipated and checked for with assertions while errors are unanticipated.

Package List

[\[Summary\]](#) [\[Package List\]](#) [\[Test Cases\]](#)

Package	Tests	Errors	Failures	Skipped	Success Rate	Time
com.oracle.daytrader.tests	3	0	0	0	100%	33.941

Note: package statistics are not computed recursively, they only sum up all of its testsuites numbers.

Welcome to Geronimo Benchmark Application on Oracle Cloud Overview

The Geronimo™ performance benchmark sample provides a suite of Apache developed workloads for characterizing performance of the Geronimo J2EE Application Server. The workloads consist of an end to end web application and a full set of primitives. The applications are a collection of Java classes, Java Servlets, Java Server Pages, Web Services, and Enterprise Java Beans built to open J2EE APIs. Together these provide versatile and portable test cases designed to measure aspects of scalability and performance.

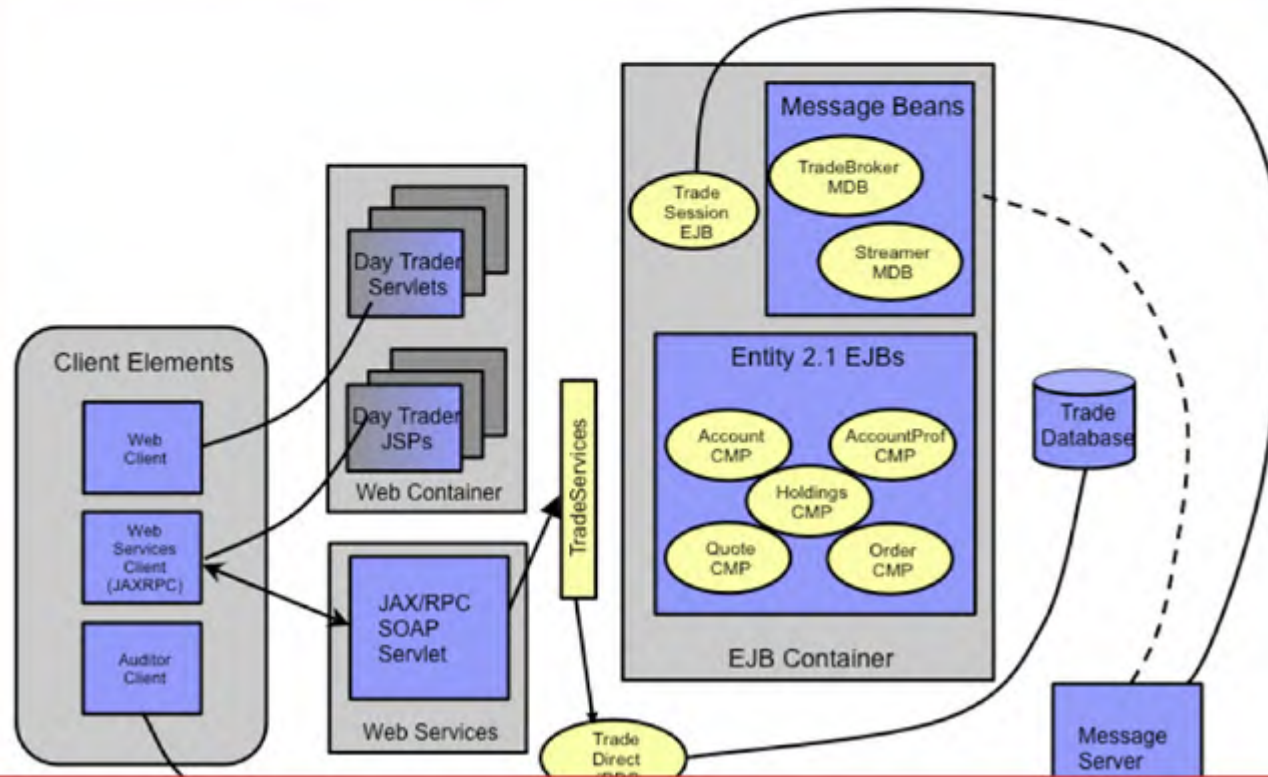



SIGN IN TO ORACLE CLOUD

Welcome hkoraclehktrial19627 [change domain](#) [?](#)

[Can't access your account?](#)

Sign In

ORACLE

Dashboard

Customize Dashboard ?

CLOUD SERVICES Identity Domain: hkoraclehkttrial19627, Data Center: US Commercial 2 (Time zone: US/Central)

Important Notifications

loganalyticstrial0325
Log Analytics

⊕ ⚙️ ☰
☁️ ✓

itanalyticstrial2218
IT Analytics

⊕ ⚙️ ☰
☁️ ✓

apmtrial1100
APM

⊕ ⚙️ ☰
☁️ ✓



Dashboard

Customize Dashboard ?



CLOUD SERVICES Identity Domain: hkoraclehktrial19627, Data Center: US Commercial 2 (Time zone: US/Central)

0 Important Notifications



loganalyticstrial0325
Log Analytics

itanalyticstrial2218
IT Analytics

apmtrial1100
APM

- View Details
- Open Service Console

Welcome to Oracle Management Cloud



Application Performance Monitoring

Rapidly identify, response, and resolve your software roadblocks



Log Analytics

Topology aware log exploration and analytics for modern applications and infrastructure



IT Analytics

Operational big data intelligence for modern IT

Select ▾



Dashboards

Build custom dashboards using out-of-the-box widgets or your own visualization of data



Data Explorers

Search, analyze, and visualize data

Select ▾

Learn More

- [How to get started](#)

All Entities

APM

- Home
- Applications
- Pages
- Ajax Calls
- Session List
- Mobile Clients
- View Controllers/Activities
- HTTP Requests
- Server Requests
- AppServers
- Synthetic Tests
- Alerts
- Administration

Home

Yesterday 02:00 pm - Today 03:34 pm

Pages By Geography

Color Average Response Time

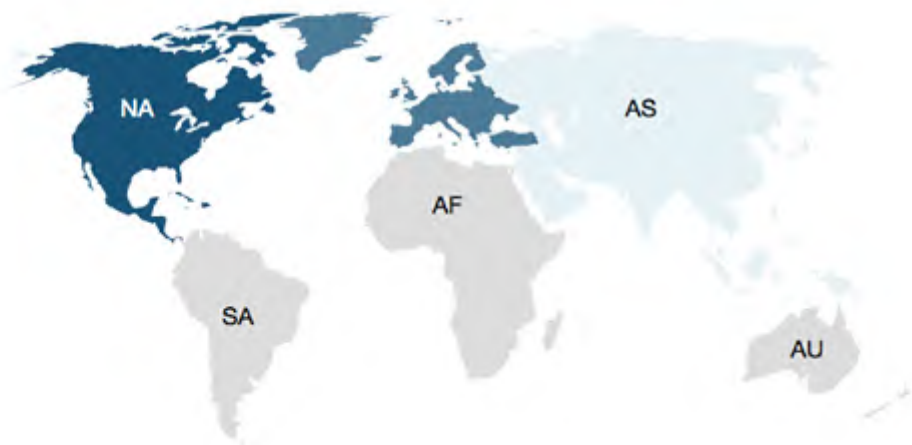

Average Response Time
763.00 ms 1.00 s

Server Requests By AppServer

Box Size Total Calls Color Average Response Time

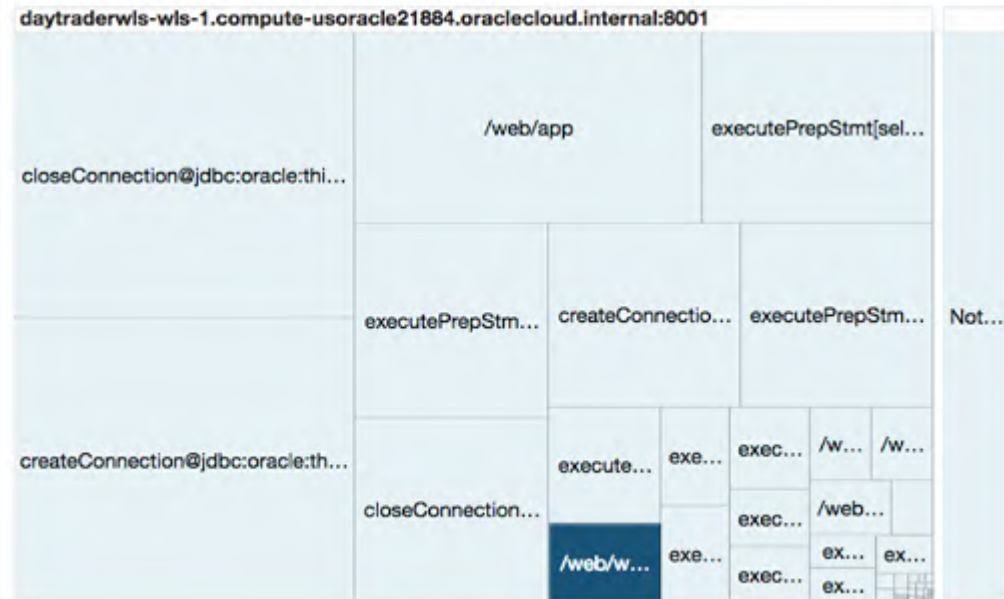

Average Response Time
0.06 ms 120.25 ms

10 Pages

Top 5 Average Load Time

http://daytraderwls-wls-1.compute-usorac ...	1.32 s
Welcome to DayTrader	

44 Server Requests

Top 5 Average Response Time

/web/welcome.faces	120.25 ms
daytraderwls-wls-1.compute-usoracle21884.oraclecloud.internal:8001	

2 AppServers

Top 5 Peak Heap Usage

daytraderwls-wls-1.compute-usoracle21884 ...	39%
daytrade_domain/daytrade_server_1	

All Entities

APM

- Home
- Applications
- Pages
- Ajax Calls
- Session List
- Mobile Clients
- View Controllers/Activities
- HTTP Requests
- Server Requests
- AppServers
- Synthetic Tests
- Alerts
- Administration

Home

Yesterday 02:00 pm - Today 03:35 pm

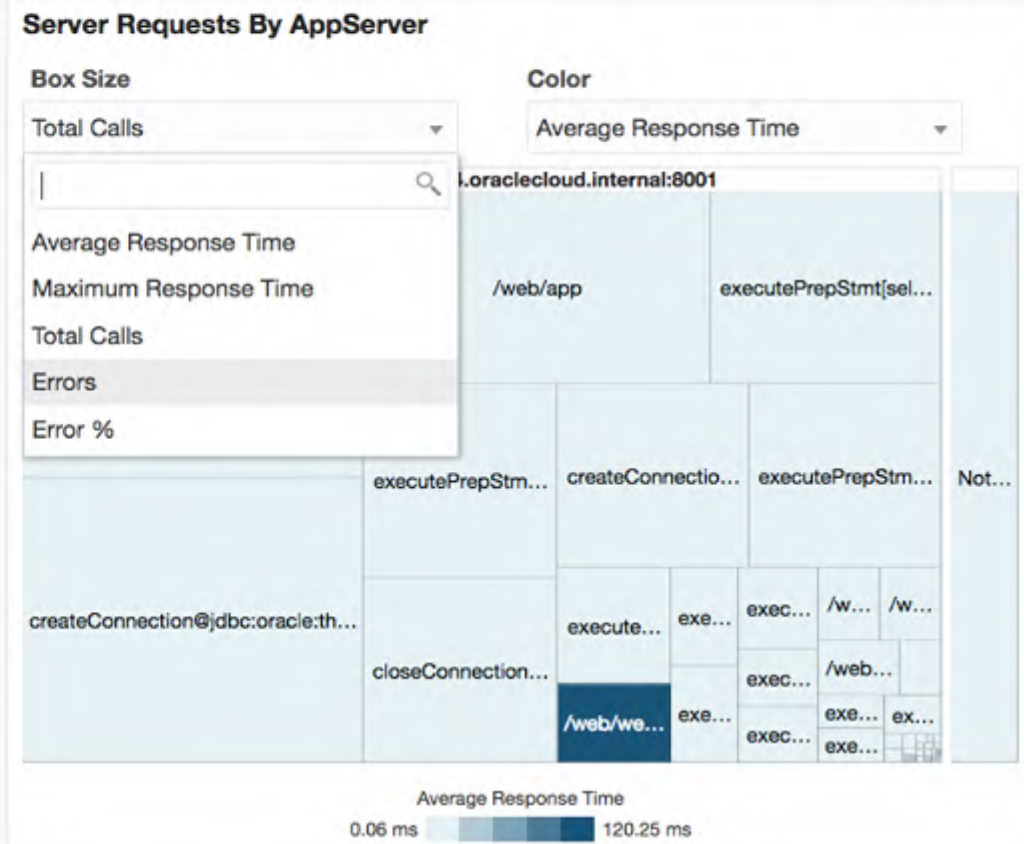
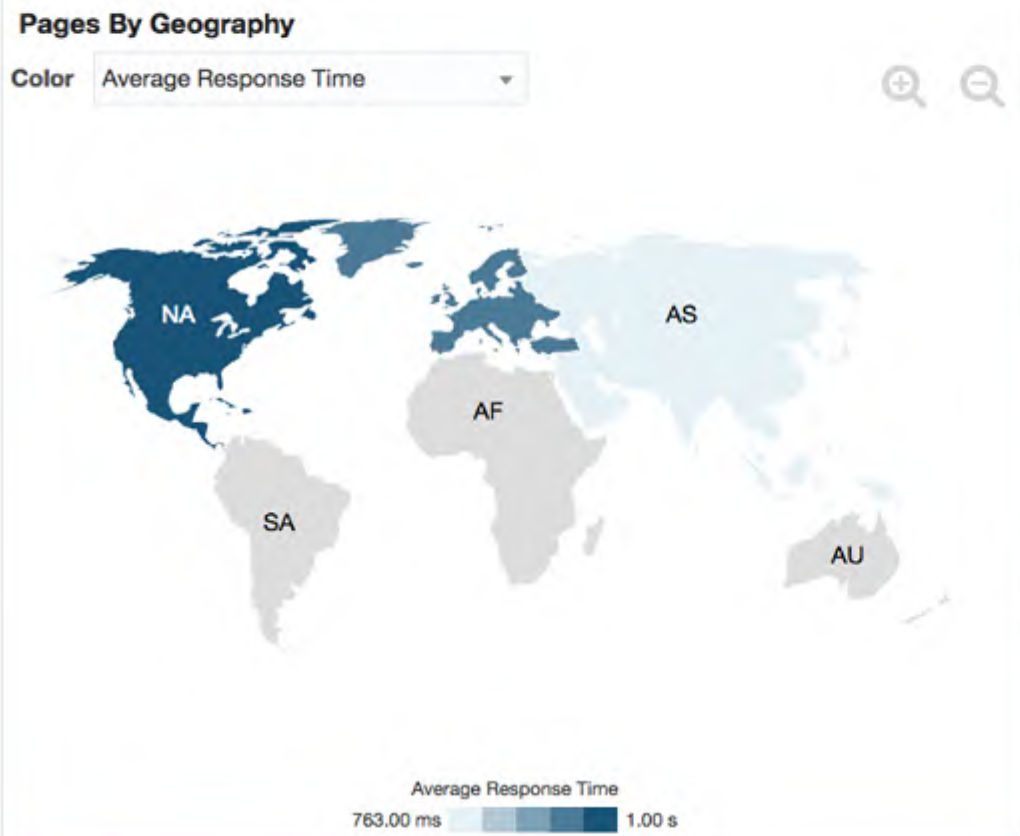

10 Pages

Top 5 Average Load Time

http://daytraderwls-wls-1.compute-usorac ...	1.32 s
Welcome to DayTrader	

44 Server Requests

Top 5 Average Response Time

/web/welcome.faces	120.25 ms
daytraderwls-wls-1.compute-usoracle21884.oraclecloud.internal:8001	

2 AppServers

Top 5 Peak Heap Usage

daytraderwls-wls-1.compute-usoracle21884 ...	39%
daytrade_domain/daytrade_server_1	

All Entities

- APM**
- Home
- Applications
- Pages
- Ajax Calls
- Session List
- Mobile Clients
- View Controllers/Activities
- HTTP Requests
- Server Requests
- AppServers
- Synthetic Tests
- Alerts
- Administration >

Home

Yesterday 02:00 pm - Today 03:35 pm

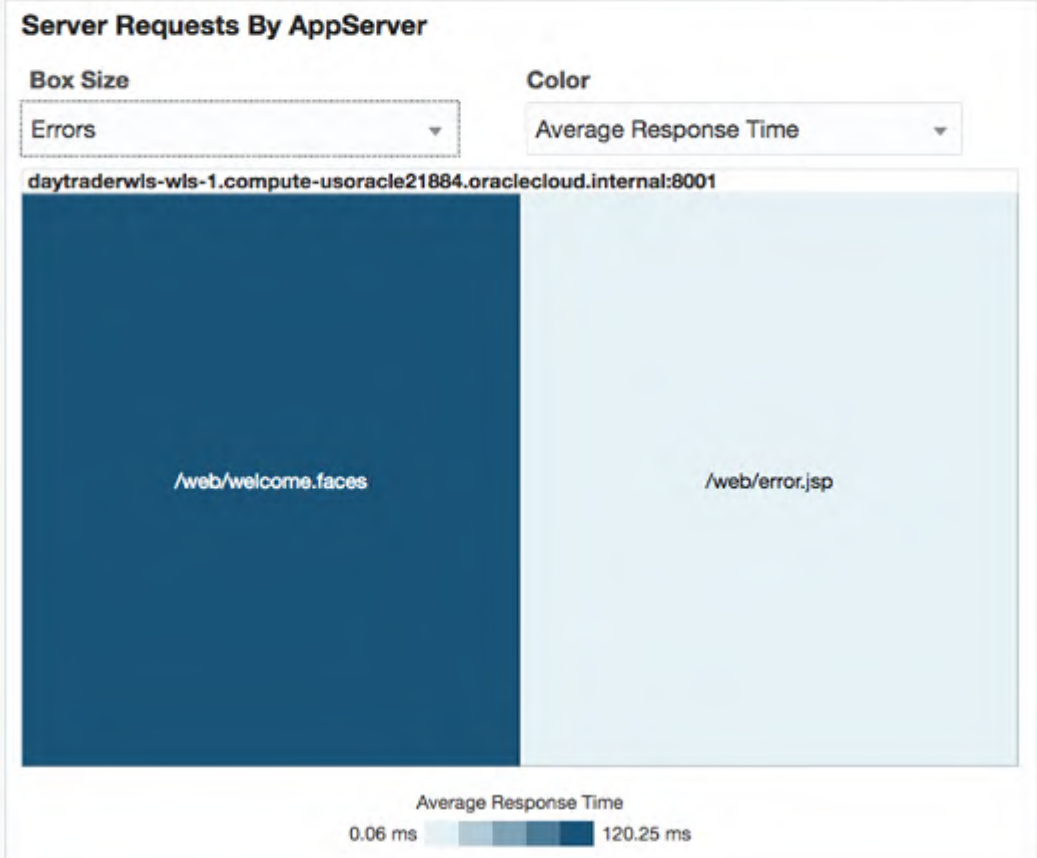
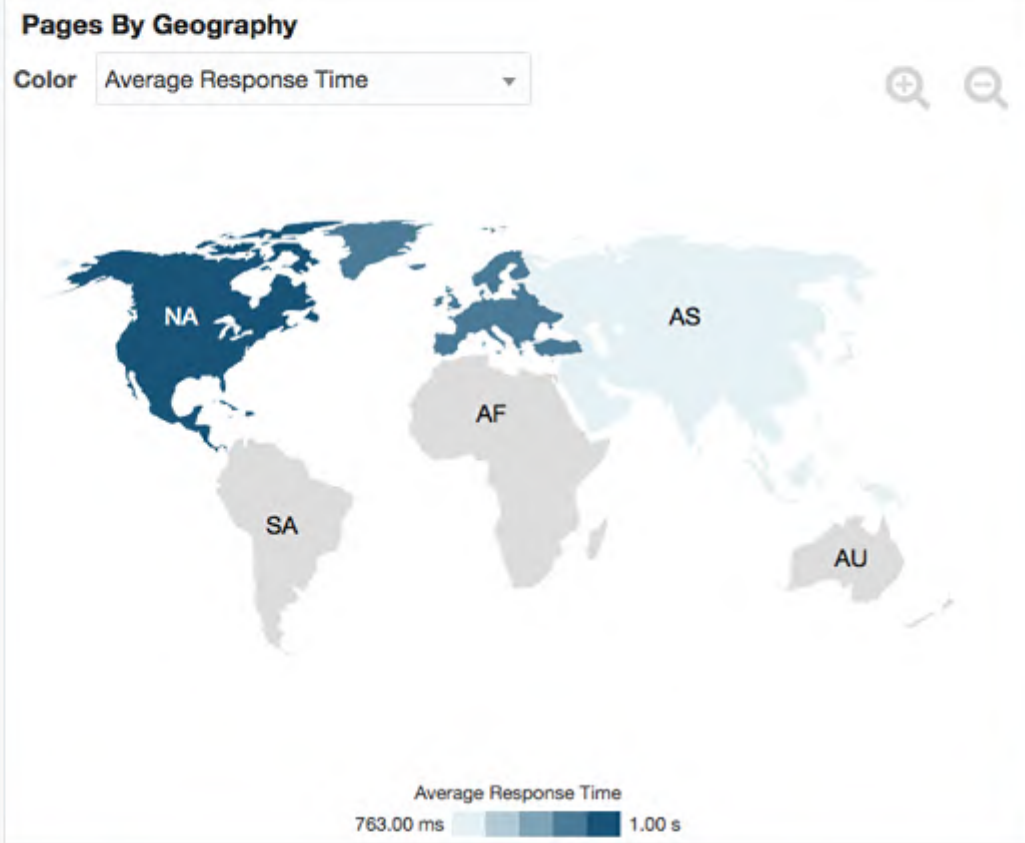

10
Pages

Top 5 Average Load Time

http://daytraderwis-wls-1.compute-usorac ...	1.32 s
Welcome to DayTrader	

44
Server Requests

Top 5 Average Response Time

/web/welcome.faces	120.25 ms
daytraderwis-wls-1.compute-usoracle21884.oraclecloud.internal:8001	

2
AppServers

Top 5 Peak Heap Usage

daytraderwis-wls-1.compute-usoracle21884 ...	39%
daytrade_domain/daytrade_server_1	

All Entities

APM

- Home
- Applications
- Pages
- Ajax Calls
- Session List
- Mobile Clients
- View Controllers/Activities
- HTTP Requests
- Server Requests
- AppServers
- Synthetic Tests
- Alerts
- Administration >

Home

Yesterday 02:00 pm - Today 03:35 pm

Pages By Geography

Color Average Response Time

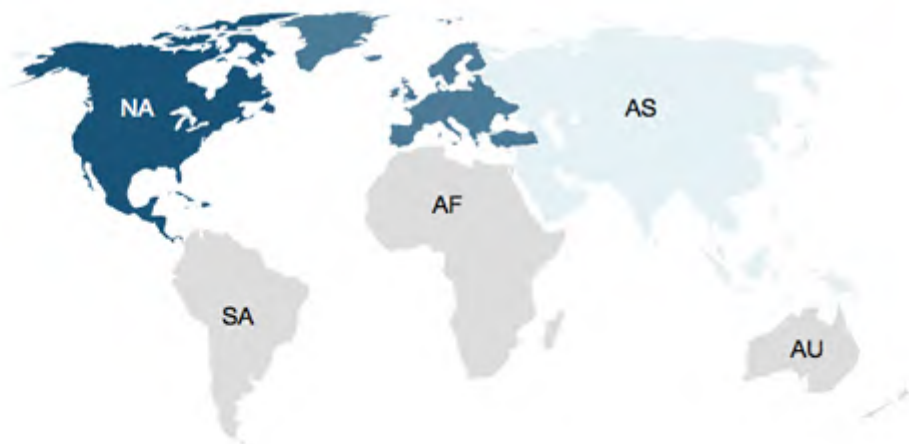

Average Response Time
763.00 ms 1.00 s

Server Requests By AppServer

Box Size

Errors

Color

Average Response Time

daytraderwls-wls-1.compute-usoracle21884.oracle

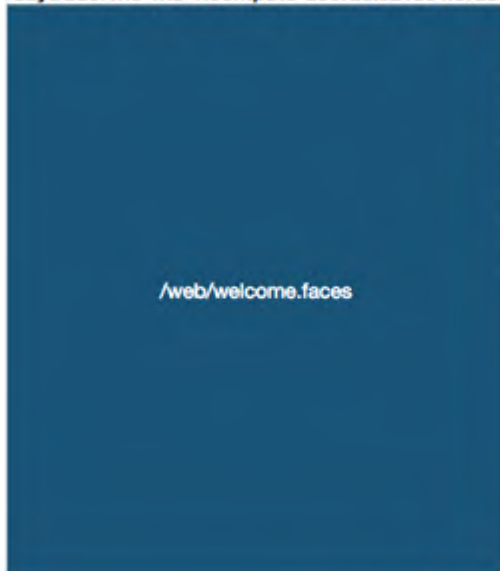

- Average Response Time
- Maximum Response Time
- Total Calls
- Errors
- Error %

/web/error.jsp

Average Response Time
0.06 ms 120.25 ms



10 Pages

Top 5

Average Load Time

http://daytraderwls-wls-1.compute-usorac ...
Welcome to DayTrader

1.32 s



44 Server Requests

Top 5

Average Response Time

/web/welcome.faces
daytraderwls-wls-1.compute-usoracle21884.oraclecloud.internal:8001

120.25 ms



2 AppServers

Top 5

Peak Heap Usage

daytraderwls-wls-1.compute-usoracle21884 ...
daytrade_domain/daytrade_server_1

39%

All Entities

APM

Home

Yesterday 02:00 pm - Today 03:35 pm

Pages By Geography

Color Average Response Time

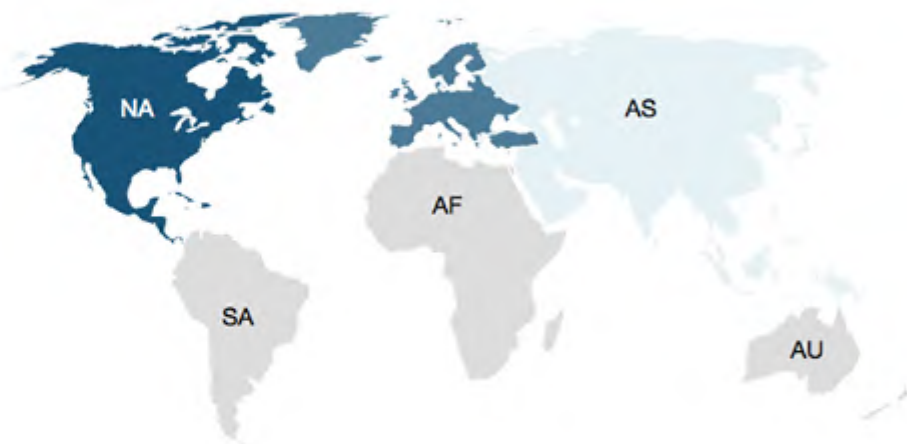

Average Response Time
763.00 ms 1.00 s

Server Requests By AppServer

Box Size

Color

Errors

Errors

daytraderwls-wls-1.compute-usoracle21884.oraclecloud.internal:8001

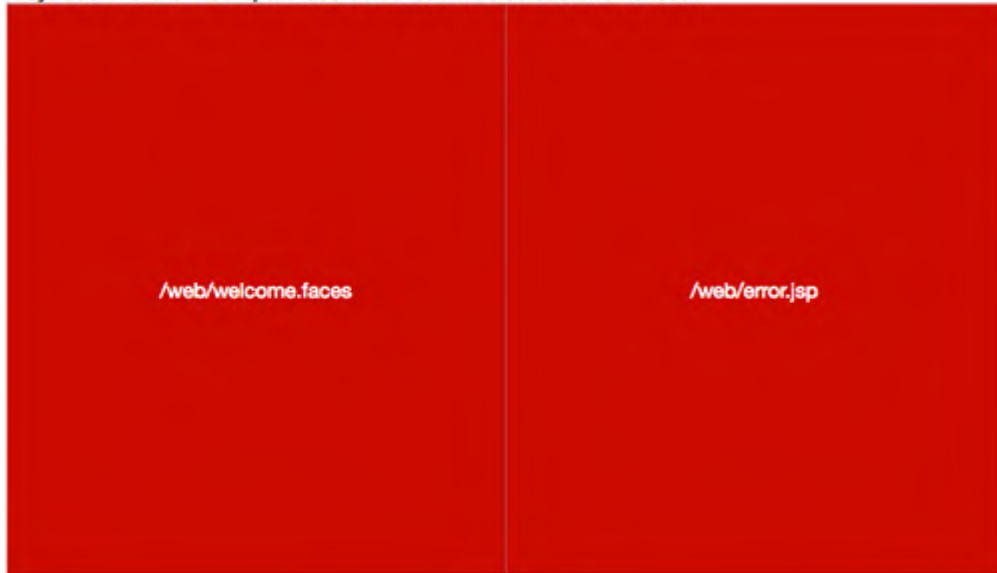

Errors
0 306



10

Pages

Top 5

Average Load Time

http://daytraderwls-wls-1.compute-usorac ...

1.32 s

Welcome to DayTrader



44

Server Requests

Top 5

Average Response Time

/web/welcome.faces

daytraderwls-wls-1.compute-usoracle21884.oraclecloud.internal:8001

120.25 ms



2

AppServers

Top 5

Peak Heap Usage

daytraderwls-wls-1.compute-usoracle21884 ...

39%

daytrade_domain/daytrade_server_1

All Entities

APM

Yesterday 02:00 pm - Today 03:35 pm

Home

Pages By Geography

Color Average Response Time

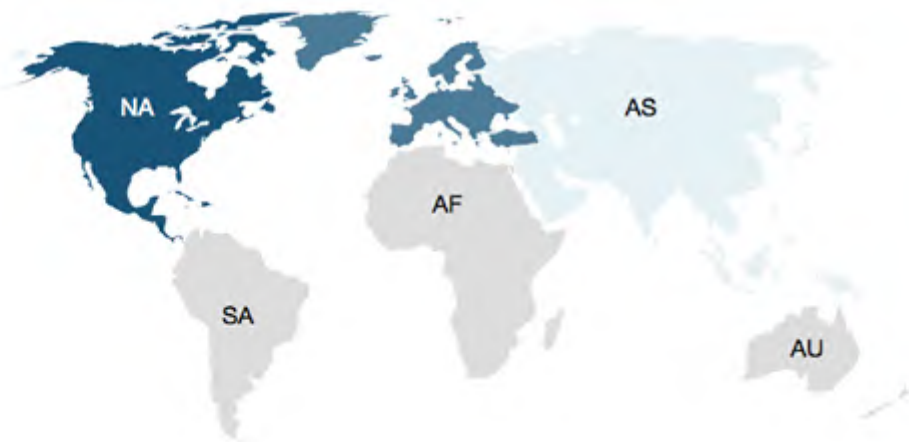

Average Response Time
763.00 ms 1.00 s

Server Requests By AppServer

Box Size

Color

Errors

Errors

daytraderwis-wls-1.compute-usoracle21884.oraclecloud.internal:8001

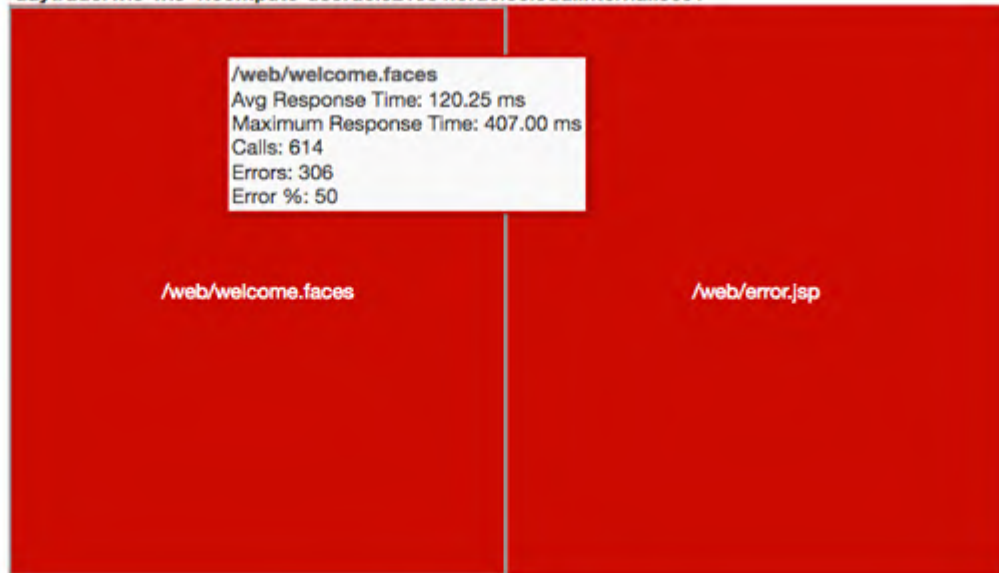

Errors
0 306



10

Pages

Top 5

Average Load Time

http://daytraderwis-wls-1.compute-usorac ...

1.32 s

Welcome to DayTrader



44

Server Requests

Top 5

Average Response Time

/web/welcome.faces

daytraderwis-wls-1.compute-usoracle21884.oraclecloud.internal:8001

120.25 ms



2

AppServers

Top 5

Peak Heap Usage

daytraderwis-wls-1.compute-usoracle21884 ...

39%

daytrade_domain/daytrade_server_1

All Entities

APM

Server Request

Yesterday 02:00 pm - Today 03:35 pm



/web/welcome.faces

Type: **SERVLET_JSF**
 AppServer: **daytraderwls-wls-1.compute-usoracle21884.oraclecloud.internal:8001**
 Deployment: **daytrader**

Alerts

0 New
0 Carried Over
0 Open at End

Request Response Time

120.25 ms avg
 Max 407.00 ms
 Min 0.00 ms
 ↓ 8.32% of prior

Tier Average Response

External 0.00%
 AppServer 99.98%
 Database <1%

Calls

<1 /min
 same as prior

Errors

49.84 %

AppServer

Heap Memory: **39.48%**
 CPU Usage: **<1%**

- Diagram
- Metrics
- Links
- Callers
- Database
- Instances
- Alerts



Diagram Controls

Node Size: Weighted Self Time

Arrow Width: Fixed Width

Tier Usage

AppServer: **99.98%**

Database: 0.03%

External: 0.00%

Tooltip

Hover over node or link to view more detail.

Weighted Self Average Response

All Entities

APM

Server Request

Yesterday 02:00 pm - Today 03:35 pm



/web/welcome.faces

Type: **SERVLET_JSF**
 AppServer: **daytraderwls-wls-1.compute-usoracle21884.oraclecloud.internal:8001**
 Deployment: **daytrader**



- Diagram
- Metrics
- Links
- Callers
- Database
- Instances
- Alerts

- Home
- Applications
- Pages
- Ajax Calls
- Session List
- Mobile Clients
- View Controllers/Activities
- HTTP Requests
- Server Requests**
- AppServers
- Synthetic Tests
- Alerts
- Administration >



Diagram Controls

Node Size: Weighted Self Time

Arrow Width: Fixed Width

Tier Usage

AppServer:

Database: 0.03%

External: 0.00%

Tooltip

Hover over node or link to view more detail.

Weighted Average
Self Response

All Entities

APM

Server Request

Yesterday 02:00 pm - Today 03:35 pm



/web/welcome.faces

Type: **SERVLET_JSF**
 AppServer: **daytraderwis-wls-1.compute-usoracle21884.oraclecloud.internal:8004**
 Deployment: **daytrader**

0
Open at End

Rec 12
 Max Response Time 241.00 ms
 Avg Response Time 117.67 ms
 Min Response Time 0.00 ms
 Date Today
 Time 04:00 - 06:00

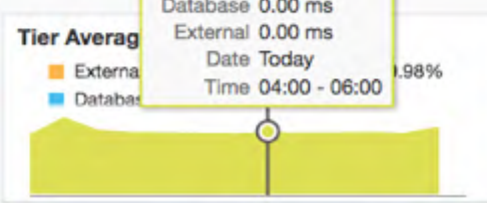

AppServer 117.67 ms
 Database 0.00 ms
 External 0.00 ms
 Date Today
 Time 04:00 - 06:00

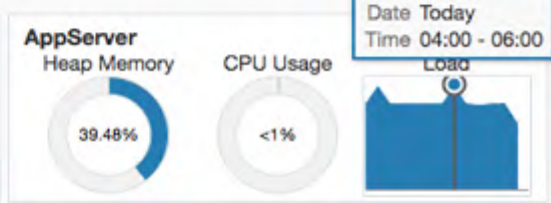
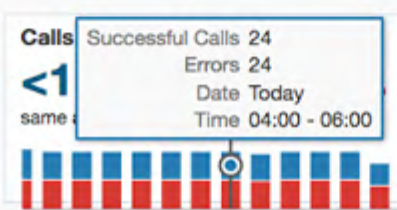

- Diagram
- Metrics
- Links
- Callers
- Database
- Instances
- Alerts



Diagram Controls

Node Size: Weighted Self Time

Arrow Width: Fixed Width

Tier Usage

AppServer	100%
Database	0.03%
External	0.00%

Tooltip

Hover over node or link to view more detail.

- Home
- Applications
- Pages
- Ajax Calls
- Session List
- Mobile Clients
- View Controllers/Activities
- HTTP Requests
- Server Requests**
- AppServers
- Synthetic Tests
- Alerts
- Administration

Weighted Average

Self Response

Call From	Call To	Tier	Weighted Self Time (ms)	Average Response Time (ms)	Total Calls	Errors
http://daytraderwls-wls-1.compute-usoracle21884.oraclecloud.internal:8001/web/welcome.faces http://daytraderwls-wls-1.compute-usoracle21884.oraclecloud.internal:8001/web/welcome.faces (there may be additional callers)	/web/welcome.faces	AppServer	120	120	614	49.84%
/web/welcome.faces	▶ executePrepStmt[select holdingdat0_.holdingdat0_.holdingid as holdingid1_2_,holdingdat0_.account_accountid as account5_2_,holdingdat0_.purchasedate as purchase2_2_,holdingdat0_.purchaseprice as purchase3_2_,holdingdat0_.quantity as quantity4_2_,holdingdat0_.quote_symbol as quote_sy6_2_ from holdingejb holdingdat0_.accountejb accountdat1_ where holdingdat0_.account_accountid=accountdat1_.accountid and accountdat1_.profile_userid=?]jdbc:oracle:thin:@//daytraderDB:1521/PDB1.usoracle21884.oraclecloud.internal	Database	0	2	1	0%
	▶ executePrepStmt[update a					

更多信息

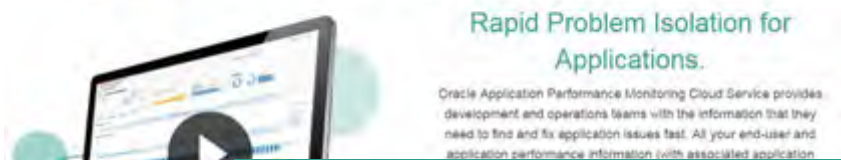
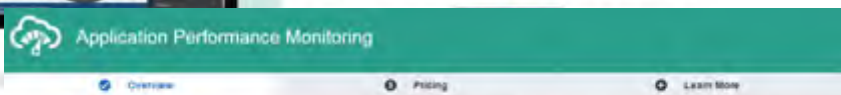
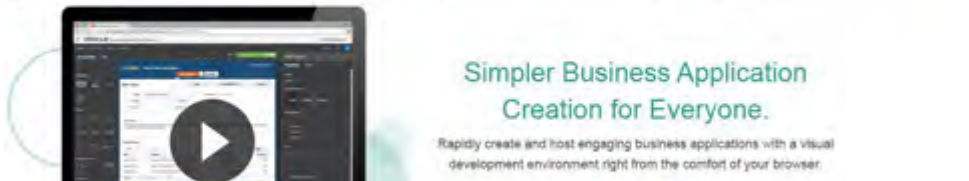
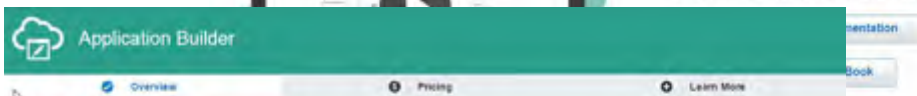

更多关于甲骨文DevOps

<https://developer.oracle.com>

甲骨文应用开发30天免费试用

<https://cloud.oracle.com/tryit>

更多社交渠道



ORACLE®

甲骨文