



OPENSTACK DAYS
CHINA

X-CBS，企业级Ceph构造OpenStack块存储解决方案

翟静 XSKY产品总监





提供企业就绪的分布式SDS产品

- 关于公司

2015年5月成立，总部位于北京

北极光创投和红点投资，A轮前融资额¥7200万

员工~70人，研发+服务~50人

公司愿景：提供企业级分布式软件定义存储产品，帮助客户实现数据中心架构革新。

产品：X-EBS分布式块存储，X-CBS云计算后端存储，X-EOS分布式对象存储等

- 研发核心

团队A：来自一线互联网，国内Ceph社区贡献领先

团队B：来自IT领导厂商的存储产品研发



Contribution by companies

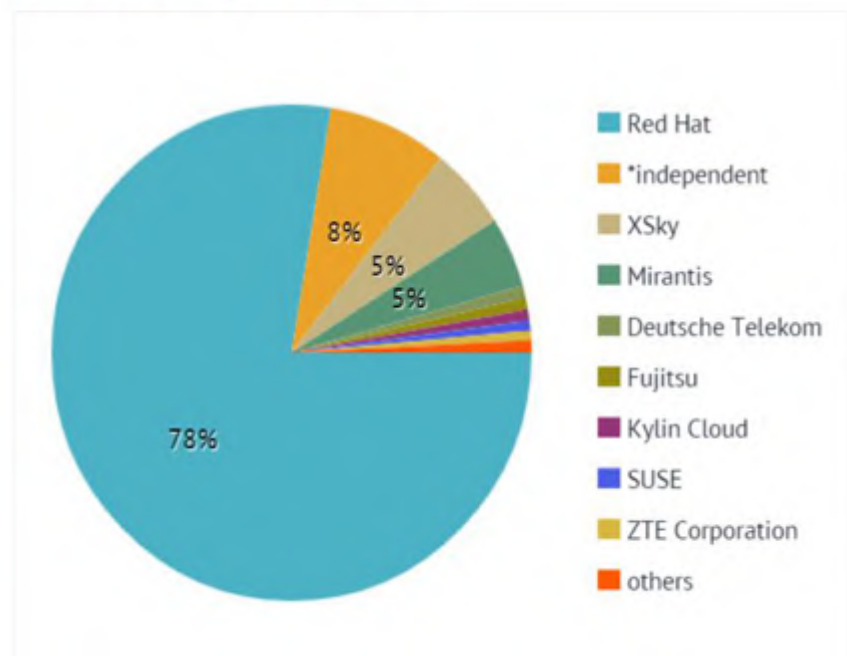

#	Company	Lines of code
1	Red Hat	175775
	*independent	18162
2	XSky	12212
3	Mirantis	10383
4	Deutsche Telekom	1789
5	Fujitsu	1752
6	Kylin Cloud	1607
7	SUSE	1484
8	ZTE Corporation	1405
9	Intel	694
10	DreamHost	339
11	Yahoo!	243
12	CERN	148
13	Huron	122
14	Reliance	86
15	Mellanox	46
16	eBay	37
17	Canonical	36
18	Qihoo 360 Technology Co	32
19	UnitedStack	14
20	ICT	11
21	EasyStack	10
22	EMC	2

Showing 1 to 25 of 25 entries

[First](#)
[Previous](#)
[Next](#)
[Last](#)

2016年 Ceph 10.0.1 新版:

XSKY源代码贡献率全球排名领先

Ceph, “存储领域的Linux” ?

Ceph 2011年1月 - 2016年2月 每月commits数量



351  3365

9.6X

Ceph 2011年1月 - 2016年2月 每月“作者”数量

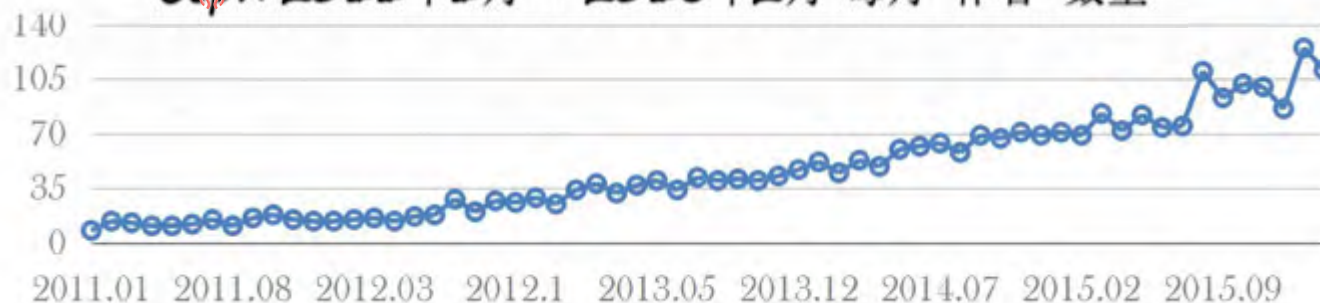

8  111

13.9X



SDS，平台的转变

存储黑盒子



通用服务器 + 存储软件 = Server SAN



融合架构



Software Defined Device



通用平台发展带来的机遇

组件	固有延迟	来回(2009)	来回(2016)
交换机	10-30us	100-300us	5us
操作系统	15us	60us	2us
网卡控制器	2.5-32us	2-128us	3us
传输	0.5us	1.0us	<1us
总共	25-70us	200-400us	11us



存储走向融合

存储黑盒子

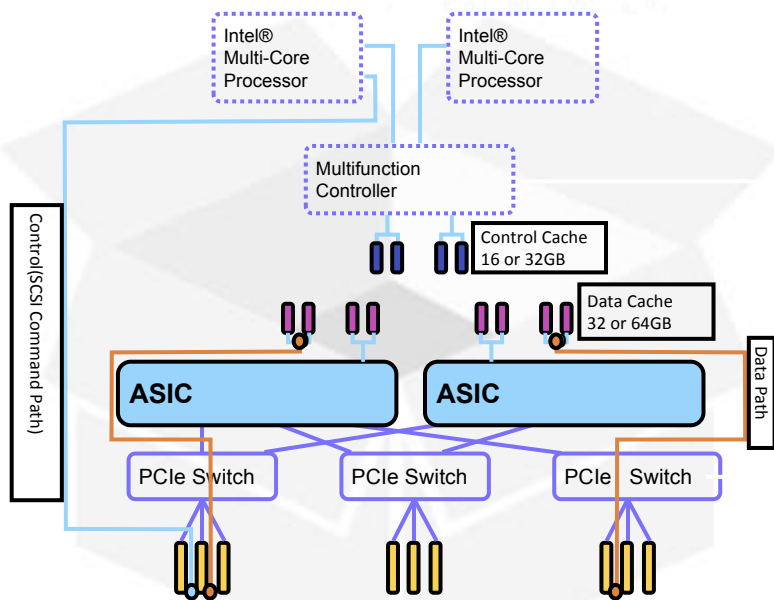

极致的单机头性能，1%应用场景

通用服务器融合

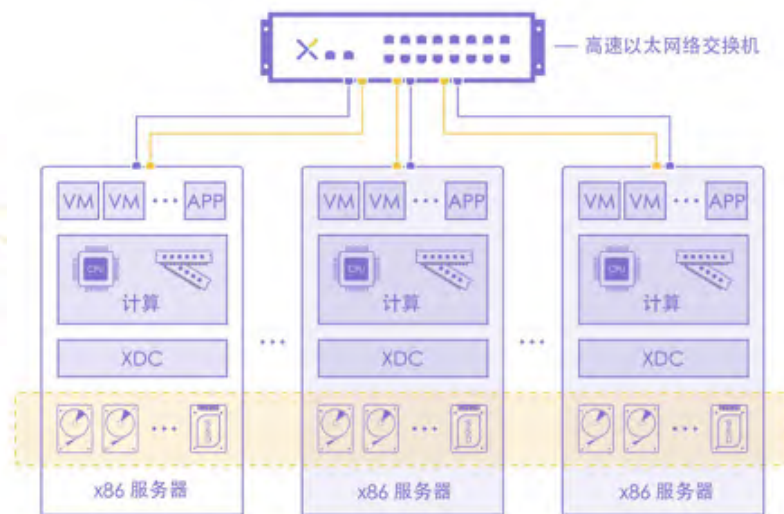

足够的性能，足够灵活度，99%应用场景



Server SAN 市场预测

Traditional Enterprise Storage, Hyperscale Server SAN & Enterprise Server SAN Revenue Projections 2012-2027

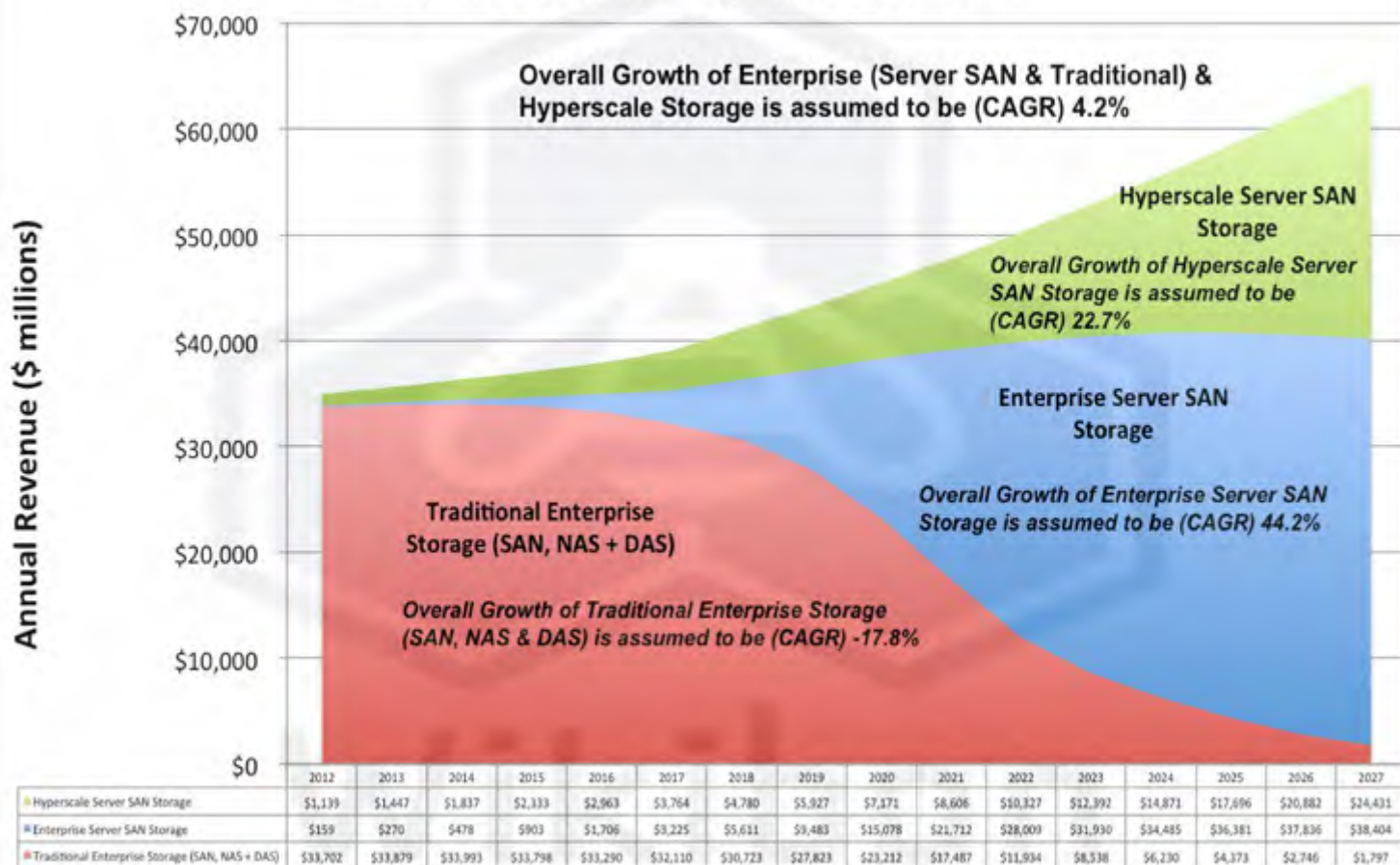

Source: © Wikibon Server SAN Research Project 2014



存储革新面临挑战



可管理性

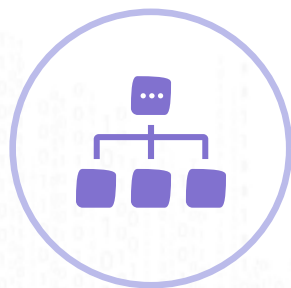

多接口和
多负载



与云环境
适配



硬件优化

2016年，25%以上的生产环境OpenStack云会因底层存储问题而陷入停滞。

Rob Whiteley - The Four Predictions of OpenStack
2016



OPENSTACK DAYS
CHINA

OPENSTACK DAYS CHINA



XSKY对Ceph的增强

- 黄色代表开源Ceph已有组成部分
- 紫色代表XSKY发行版增强的部分

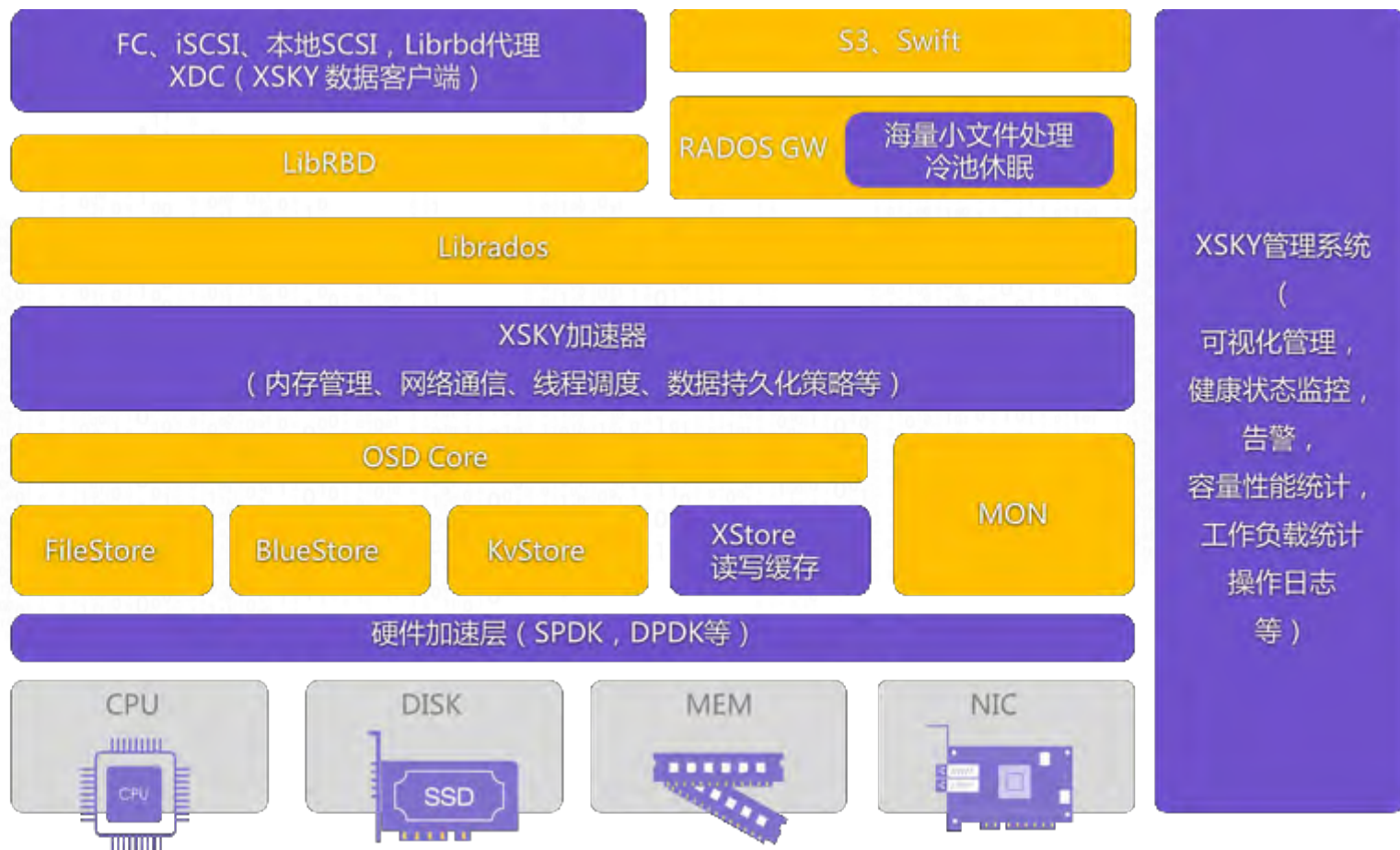

技术架构

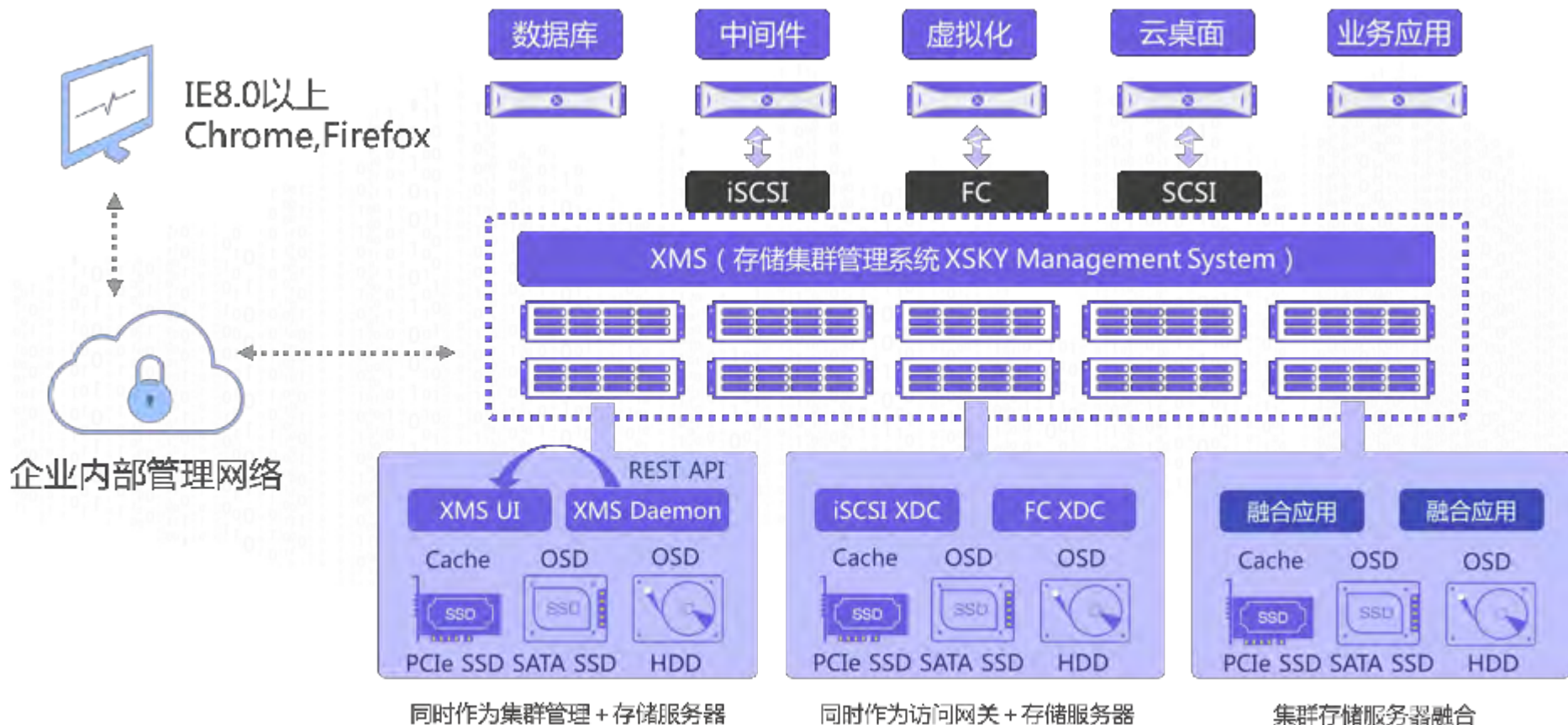

卷级QoS

❖ 用户面临的挑战：

- ❖ 不同的业务对性能需求不同
- ❖ 在任何情况下都需要保证核心业务服务能力
- ❖ “噪音”客户端容易影响集群整体性能

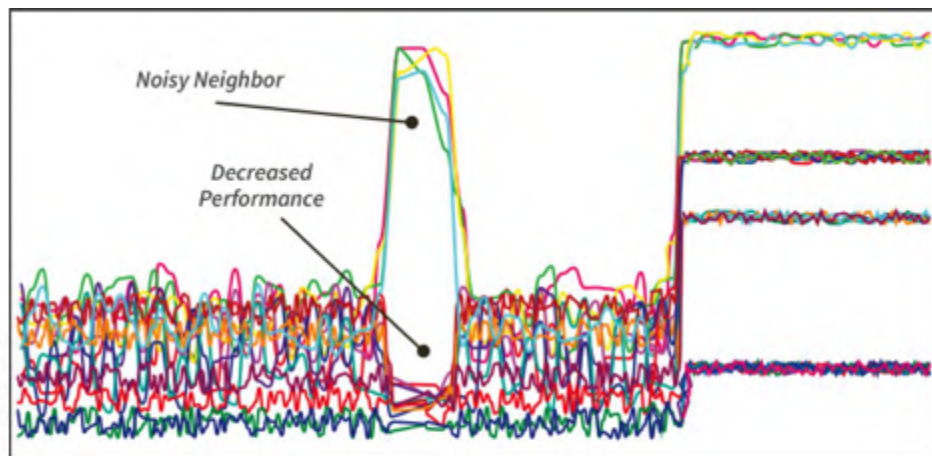

❖ 解决方案：

- ❖ 存储系统不但为业务分配容量，也需要分配服务能力（QoS）
- ❖ 优先级客户端: 块存储里的卷，对象存储里的 Bucket 和文件存储的目录将支持优先级设置，从客户端，网络带宽到存储节点提供优先级支持
- ❖ 支持卷级按IOPS、BW两种方式分配性能资源，可配置突发性能需求（Burst）。
- ❖ 支持QoS特征实时更改生效

数据重平衡QoS

❖ 用户面对的挑战：

- ❖ 系统重平衡带宽与业务带宽相互影响
- ❖ 各个业务对重平衡需求不一致
 - ❖ 业务优先 vs. 数据可靠性优先

❖ 解决方案：

- ❖ 在存储池的范围内设置Recovery QoS，根据不同的业务类型设置不同的策略：
 - ❖ 静态设置QoS，限制最大带宽。
 - ❖ 动态设置QoS，系统动态的调整带宽。

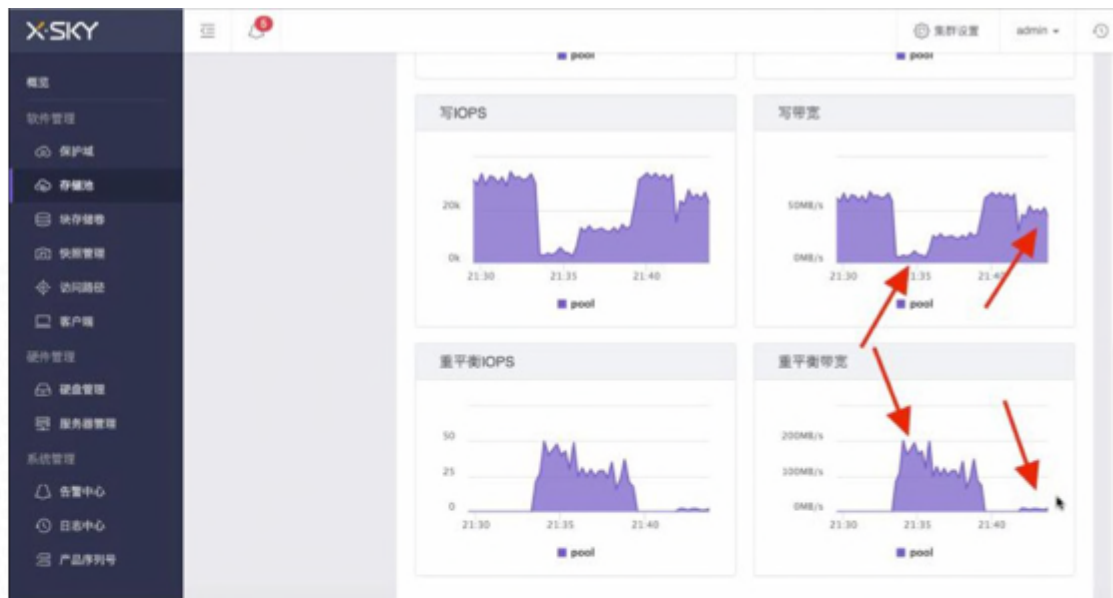

持续服务与在线运维



- 在线插拔光纤不中断业务
- 插拔硬盘实时告警



XSKY产品线

X-CBS

X-CBS 云计算后端存储

X-CBS 是XSKY 专门为Linux环境虚拟化提供的分布式块存储解决方案产品，适配国内外大多数OpenStack发行版和其他基于开源的自主可控云平台软件。

可支持超融合和存储计算资源池分离两种部署方式。

应用场景：OpenStack / CloudStack / Zstack，基于KVM与XEN的虚拟化



X-EBS

X-EBS 分布式块存储

X-EBS 是XSKY基于软件定义的通用分布式块存储的发行版，支持包括KVM，ESXi，XEN，Hyper-V，Docker，OpenStack，OLTP和OLAP数据库等SAN存储适用的应用。

X-EBS 是专门为大并发，高性能，高压力，弹性扩展需求的客户所量身定做的解决方案产品。

应用场景：虚拟化 / 数据库 / 结构化数据 / 低延迟 / 替代SAN

X-EOS

X-EOS 分布式对象存储

X-EOS 是XSKY基于软件定义的分布式对象存储的发行版，X-EOS不但可以帮助运营商与云服务商实现数10个PB规模的存储资源池，也可以帮助企业实现成本可控的中小规模水平扩展存储。

X-EOS 是专门为高性价比和容量需求型客户，量身定做的解决方案产品。

应用场景：视频，影音，图片，流媒体 / 非结构化数据 / 性能容量比



X-CBS 云计算后端存储产品

XSKY Cloud Block Storage

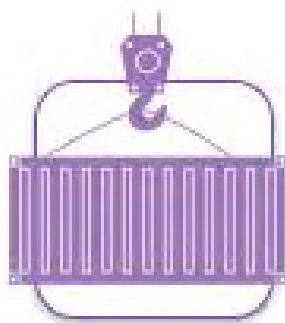

高度集成



便捷交付

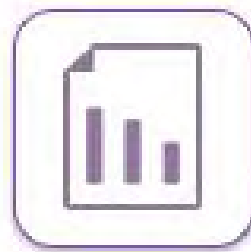

降低开销



融合云



两种部署方式

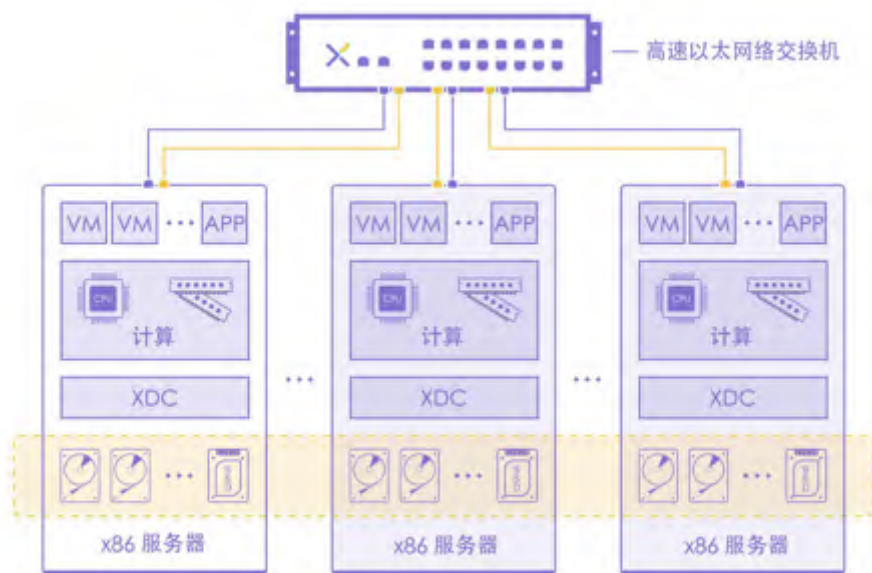

超融合部署架构

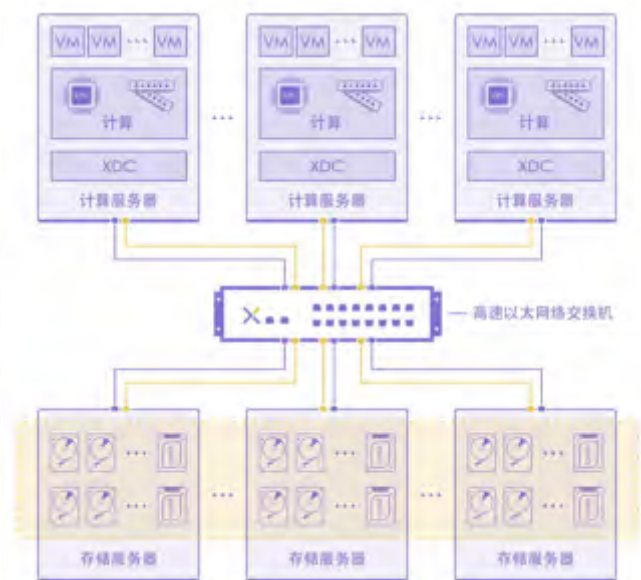

资源池分离部署架构



OpenStack与X-CBS的交互

- 创建虚拟机
- 创建镜像
- 创建块存储卷
- 块存储卷生命周期管理
- 创建卷快照及克隆块存储卷



- 创建保护域、存储池
- 块存储卷管理与监控
- 批量设置块存储卷QoS
- 卷快照管理
- 硬件资源管理与监控



Demo



X-CBS 云计算后端存储解决方案

LibRBDProxy, 增强超融合性能

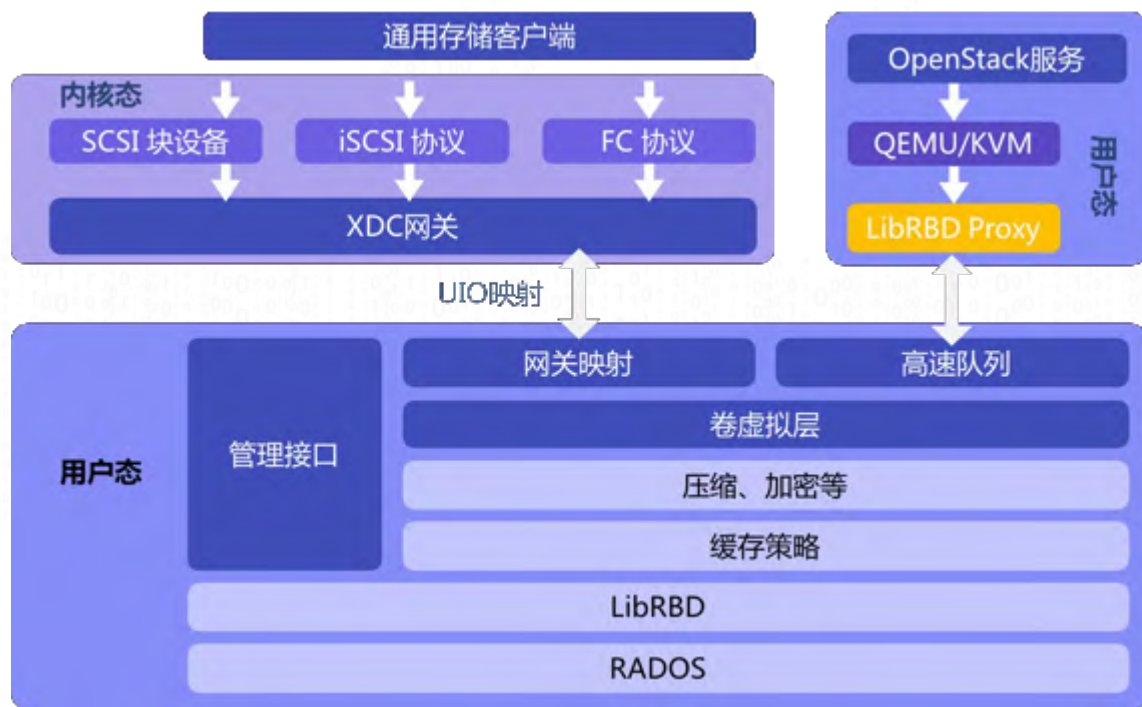

使用了“增强LIBRBD”后...

1. 4K随机写IOPS提升20%
2. IO延迟降低15%
3. CPU利用率降低40%
4. 内存使用至多减少2/3



云平台解决方案合作伙伴



Thanks

